

Systematic Literature Review: Development of The Leach Protocol Algorithm for Efficient Energy Consumption in WSN

Abstract. Efficient energy consumption routing protocols in the field of Wireless Sensor Networks (WSN) still receive considerable attention from researchers. One model is the Low Energy Adaptive Clustering Hierarchy (LEACH) which has continued to develop from 2000 until now. The level of energy efficiency is determined by the size of energy consumption. The benefit of increasing energy efficiency is to extend the life of the network. The aim of this research is to present published information about the development of the LEACH protocol in its role in overcoming the problem of limited energy in WSNs, which has an impact on network lifespan. This research uses the Systematic Literature Review (SLR) method, to analyze high quality articles from the last six years (2017 – 2023) taken from six databases, namely IEEEEXPLORE, Springer, Elsevier, ScienceDirect, Taylor & Francis, and MDPI. The results of the study show that researchers are very enthusiastic about conducting research in the field of energy consumption in WSNs with the development of the LEACH protocol. The information obtained contained 68% of protocols with Leach's development, 16% of protocols related to Leach, and 16% of protocols not Leach, From the Geographic Space study, it can be seen that there are 11 active countries, with nine countries having quite high activity, India ranks first as the most active country reaching 33%. Based on research methodology, it shows that the experimental method is in the highest position with a total of 37 papers published.

Streszczenie. Protokoły routingu efektywnego zużycia energii w dziedzinie bezprzewodowych sieci czujników (WSN) nadal cieszą się dużym zainteresowaniem badaczy. Jednym z modeli jest hierarchia klastrów adaptacyjnych niskoenergetycznych (LEACH), która rozwija się od 2000 r. do chwili obecnej. Poziom efektywności energetycznej zależy od wielkości zużycia energii. Korzyścią ze zwiększenia efektywności energetycznej jest wydłużenie żywotności sieci. Celem badań jest przedstawienie opublikowanych informacji na temat rozwoju protokołu LEACH w jego roli w przewidywaniu problemu ograniczonej energii w WSN, który ma wpływ na żywotność sieci. W badaniu wykorzystano metodę Systematic Literature Review (SLR) do analizy wysokiej jakości artykułów z ostatnich sześciu lat (2017 – 2023) pobranych z sześciu baz danych, a mianowicie IEEEEXPLORE, Springer, Elsevier, ScienceDirect, Taylor & Francis i MDPI. Wyniki badania pokazują, że badacze z dużym entuzjazmem podchodzą do prowadzenia badań w zakresie zużycia energii w WSN wraz z rozwojem protokołu LEACH. Uzyskane informacje zawierały 68% protokołów z opracowaniem Leacha, 16% protokołów związanych z Leachem i 16% protokołów niezwiązanych z Leachem. Z badania przestrzeni geograficznej wynika, że istnieje 11 aktywnych krajów, przy czym dziewięć krajów ma dość wysokiej aktywności, Indie zajmują pierwsze miejsce wśród najbardziej aktywnych krajów, osiągając 33%. Z metodologii badań wynika, że na najwyższym miejscu znajduje się metoda eksperymentalna, w której opublikowano ogółem 37 prac. (**Systematyczny przegląd literatury: Opracowanie algorytmu protokołu wymywania w celu efektywnego zużycia energii w WSN**)

Keywords: Leach development, SLR, WSN, Energy Consumption

Słowa kluczowe: Rozwój ługowania, SLR, WSN, Zużycie energii

Introduction

A wireless sensor network (WSN) is a system that uses wireless communications to connect many sensor nodes, with applications covering various fields such as military[1], environmental monitoring[2], medical care[3], smart city[4], and industrial automation[5]. Researchers have emphasized the importance of energy conservation in WSNs due to limited battery capacity at sensor nodes and the need to extend the network's lifetime. In response, they have explored various protocol algorithm techniques, including duty cycling, data aggregation, clustering, and energy harvesting, to reduce energy consumption and improve network performance [6][7]. Some energy efficient routing protocols used in WSN include HEED (Hybrid Energy Efficient Distributed) which was first published in 2004[8], TEEN (Threshold sensitive Energy Efficient sensor Network), which is designed to transmit data only when significant changes occur in the data measured[9], EORA (Energy Optimized Routing Algorithm) which focuses on saving energy in multi-sink networks[10], PEGASIS (Power Efficient Gathering in Sensor Information Systems) which uses a chain-based structure to reduce energy consumption[11], and LEACH (Low-Energy Adaptive Clustering Hierarchy) was created in 2000 and continues to be developed to balance energy consumption at each node in the network[12]. LEACH is one of the most popular energy-efficient routing protocols in WSN [13][14][15].

Each of the protocols mentioned has undergone significant version development and has been proposed in the literature with various specific improvements that optimize its performance. The updated PEGASIS protocol, for example, has integrated the energy consumption of all

nodes, reducing overhead by implementing a chain-based approach without the need to form dynamic clusters, resulting in a reduction in overhead and a marked increase in energy efficiency[16]. Meanwhile, the improved HEED protocol succeeded in reducing communication requirements between sensor nodes, which resulted in reducing communication overhead and improving clustering, with the aim of designing energy-efficient networks that can extend the lifetime of wireless sensors[17]. In addition, in a survey of communication protocols for WSN, the SPIN protocol changed the communication paradigm from one-to-one to one-to-many, which aims to reduce energy consumption and increase efficiency in wireless sensor networks[18]. Meanwhile, the TEEN protocol is an evolution of LEACH, where all nodes take turns acting as Cluster Head (CH) to maintain short routes, resulting in benefits in the form of energy savings, increased accuracy, data transmission speed, reproducibility, and error reduction[19][20]. The LEACH protocol, as one of the early protocols in WSNs, has been the focus of extensive research, with researchers pursuing continuous improvements in the cluster formation process, CH selection algorithms, stability, and energy efficiency to overcome various challenges arising in the use of these networks[13][21]. Thus, continuous developments and improvements in WSN protocols have resulted in significant improvements in the energy efficiency and performance of wireless sensor networks.

The results of the experimental comparisons that have been carried out reveal significant progress in the improved LEACH protocol in terms of energy conservation. This protocol successfully maintains its nodes over long periods

of operation, namely up to 9000 seconds, while its network life cycle is also more durable than the standard LEACH version. These results confirm the reliability of the improved approach as presented in the study[22]. More importantly, the energy consumption during operation of the enhanced protocol is consistently lower compared to standard LEACH, a fact that is particularly advantageous in the context of WSN deployment[22][23]. Therefore, the improved LEACH communication protocol provides a strong theoretical foundation for energy-efficient and effective transmission in WSNs, which can support further development and application in the ever-expanding world of WSNs.

In continuing efforts to improve WSN efficiency, it has been found that the Anchor Point Algorithm with Clustering (APAC) algorithm plays an important role. APAC uses a more optimal approach by selecting anchor points via a point substitution method, which in turn collaborates with the LEACH protocol to implement an intelligent clustering method. The results of this research show that by utilizing APAC, data transmission latency in the network can be reduced significantly, surpassing the performance of the single point substitution method[24]. Thus, the integration of APAC with LEACH shows great potential for improving the operational efficiency and overall performance of wireless sensor networks, having a positive impact on the future development of wireless sensor technology.

In recent years, there has been a significant increase in literature reviews related to energy consumption efficiency in WSNs. Many surveys and review scientific articles have been published on this topic, with research including a careful classification of routing protocols based on various aspects such as operation, environment, and purpose, as well as a synthesis of several related publications. The aim is to provide an in-depth analysis of how reducing energy consumption can extend the lifetime of WSN[25]. In addition, a literature review that focuses on efforts to minimize energy expenditure, maximize node utilization, and extend network lifetime has also been conducted to explore concepts that can improve energy consumption efficiency in WSNs[26]. Literature research covers various aspects, both technical and non-technical, such as the integration of wireless technology and the collaboration of various types of Wireless Sensors (WS) to form WSNs. In this case, they provide a comprehensive overview of the role of WS and present a complete list of Key Performance Indicators (KPI)[27]. All of this research is highly relevant to developments in computing, WSNs, and machine-to-

machine networks, which are increasingly becoming the Internet of Things (IoT). In IoT, communication over the internet connects heterogeneous physical devices with unique address identification. In this literature review, the communication protocol architecture is also explained and described extensively[28]. Lastly, in an effort to meet WSN energy needs, Radio Frequency (RF) has been identified as an energy source that can be utilized through energy harvesting. This paper details the motivation for RF energy harvesting to power WSN components, and discusses the latest techniques in order to improve the overall rectenna power conversion efficiency[29].

All these studies together have a positive impact in achieving higher levels of energy efficiency and extending the lifetime of wireless sensor networks.

Based on literature studies that have been published over the last six years, it can be concluded that in this research domain, there has been no in-depth systematic literature review (SLR) regarding the development of the LEACH protocol algorithm, to increase the efficiency of energy consumption in WSNs. Therefore, this SLR research aims to fill this gap by identifying, classifying, selecting, evaluating and synthesizing papers relevant to the development of the LEACH algorithm for WSN. The method used involves collecting reliable and detailed data from scientific articles discussing the development of the LEACH algorithm in the period 2017 to 2023. The objectives of this literature study are as follows:

- Collect data systematically regarding the development of the LEACH algorithm for energy consumption efficiency in WSN.
- Conduct in-depth analysis regarding energy consumption in WSN.
- Present informative evaluation results regarding energy consumption in WSN.
- Identifying challenges that may be faced in developing the LEACH protocol algorithm to increase energy consumption efficiency in WSNs. The results of

This literature study will be presented in an organized structure, consisting of theoretical sections “related to the development of the LEACH algorithm”, “research methods used”, “results of classification”, “selection and evaluation,” and “discussion of the findings”. The findings and “conclusions”. All this information will be illustrated in a diagram as shown in Figure 1 which will be presented in detail in our paper.

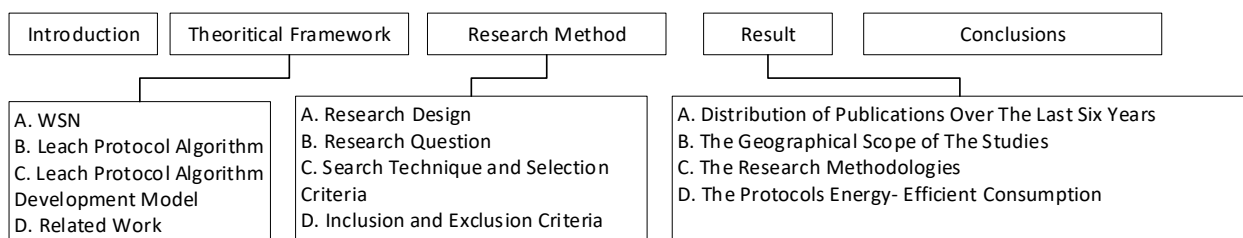

Fig. 1. Structure Diagram of Paper

The Theoretical Framework

A. Wireless Sensor Networks (WSN)

Low-power Wireless Sensor Networks today remain an important computing platform that is widely used for monitoring and surveillance purposes[30]. Mobile Wireless Sensor Networks (MWSN) are a fundamental element of the Internet of Things (IoT) involving hundreds to thousands of Sensor Nodes (SN) connected in a Wireless Networks (WN) and providing a digital interface to devices. Nevertheless, there are still challenges to be overcome

including energy consumption, connectivity, scalability, and security[31].

B. The Leach Protocol algorithm.

Based on our knowledge, the LEACH protocol algorithm was first written by W.R. Heinzelman in 2000. This protocol was developed from two different approaches. The first approach is a direct communication protocol, where each sensor node sends data directly to the base station with the support of a large amount of energy. Meanwhile, the

second approach is a "minimum-energy" routing protocol that uses multi-hop routing with minimum energy usage in sensor networks. The radio model used in this research is illustrated in Figure 2.

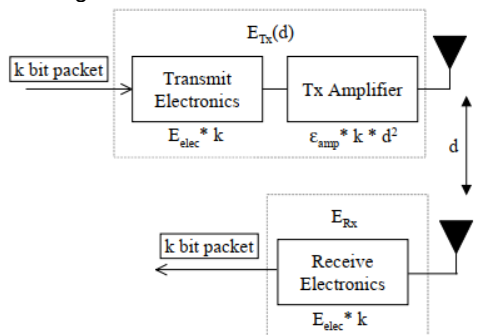

Fig. 2. Radio Model

The energy consumption of information transmission is described in equation (1),

$$E_{Tx}(k, d) = E_{Tx-elec}(k) + E_{Tx-amp}(d)$$

$$(1) \quad E_{Tx}(k, d) = E_{elec} * k + \epsilon_{amp} * k * d^2$$

The energy consumption of the receiving part is described in equation (2),

$$E_{Rx}(k) = E_{Rx-elec}(k)$$

$$(2) \quad E_{Rx}(k) = E_{elec} * k$$

C. Leach Protocol Algorithm Development Model

The development of the LEACH algorithm by *B. Pitchaimanickam*, which uses CH selection optimization in Leach Clustering (Leach-C) combined with the Hybrid approach of Firefly Algorithm with Particle Swarm Optimization (HFAPSO) technique, has resulted in an increase in energy consumption efficiency when compared to Leach-C[32]. Leach protocol modification is carried out by improving the hierarchical protocol which uses a CH selection algorithm based on cache node selection to send information from the CH to the sink. CH selection is based on a comparison between the residual energy and the energy threshold, and data transfer from the CH to the sink is carried out by finding the shortest distance. Cache node replacement is based on priority[33].

Stability of the Improved-LEACH (SILEACH) works by balancing the load between nodes by considering the distance between the node and the sink, as well as the remaining energy in determining CH[34]. Five input fuzzy-based unequal clustering protocol (F5NUCP) uses five input parameters: remaining energy, distance to BS, distance to its neighboring nodes, link quality, and node degree. The approach used is non-probabilistic in selecting a tentative CH by using a countdown time that is set based on the remaining energy of the node[35].

LEACH Algorithm based on Energy Consumption Equilibrium does not select nodes close to the sink as CH simultaneously, but rather nodes communicate directly with the sink[36]. Anchor point algorithm with clustering main aim is to reduce latency by combining node substitution and clustering methods[24]. Author R. Gantasi proposed a combination of the LEACH-K protocol, Mobile Data Collectors (MDC), and Traveling Salesman Problem (TSP) to form a protocol development called MDC-TSP-LEACH-K [37]. Hybrid protocol of MDC-K is a combination of algorithms between K-Means machine learning clustering and mobile data collector (MDC) to improve QoS performance in large-scale wireless sensor networks (LSWSNs)[8]. Fuzzy Logic (FL) low-energy adaptive clustering hierarchy (LEACH) technique-based particle swarm optimization (PSO) combines FL to select primary

CH (PCH) and secondary CH (SCH), LEACH, as well as a combination of PSO and K-Means to form clustering[38].

D. Related Work

This section aims to provide an overview and analysis of existing literature studies as well as a survey of relevant research in the same field. The focus is on research works that can make an important contribution to understanding and strengthening the needs of this Systematic Literature Review (SLR). One relevant research is the work carried out by S. El Khedhiri, who examines K-means clustering algorithms that have been optimized to improve energy efficiency in the context of Wireless Sensor Networks. The main goal of this algorithm is to efficiently manage the energy consumption of wireless sensor nodes so as to increase the lifetime of wireless sensor networks, which often operate within a limited scope. This research introduces a new methodology that uses an improved K-means clustering algorithm, known as Optimal K-means (OK-means), to form multiple clusters of sensor nodes. Simulation results show that this algorithm successfully achieves an even distribution of clusters in the Cluster Head spatial domain and efficiently balances energy consumption [39]. In addition, this SLR also provides comprehensive insights related to Industry 4.0, identifies research areas that require further attention, and details potential future research directions. It covers various aspects, from the initial design stage to the required network security protocols, as well as the network deployment and classification process[5]. In the context of the significant growth of the Internet of Things due to the more affordable costs of sensors and actuators, IoT network security has become a major concern. Especially, IoT network layer security issues, such as routing protocols, have become the focus of attention. To overcome this, an Intrusion Detection System (IDS) is used to detect potential threats. In addition, this article also discusses Adversarial Machine Learning (AML) in the context of wireless and mobile systems. AML is an attack on Machine Learning (ML) models that can deceive modeling with samples that appear normal but have imperceptible interference. This research explores the challenges and opportunities in the field of artificial intelligence to improve the security and efficiency of increasingly important wireless and mobile networks[40][41]. The literature study reviews the optimization of the trajectory of mobile elements in WSNs as well as energy saving schemes in WSNs to increase efficiency and battery life. Apart from that, research also discusses routing problems in autonomous flying networks (FANET) using Bio-Inspired Algorithms (BIA) through a Systematic Literature Review [42] [43] [44]. Although a lot of research has been carried out in developing the LEACH protocol algorithm to increase the efficiency of energy consumption in Wireless Sensor Networks, to date there has been no systematic investigation carried out through a Systematic Literature Review (SLR). Table 1 provides a list of relevant research observations, survey studies, and methods, along with the limitations of each study. Reference [3] focuses research on energy efficiency in WSNs with non-SLR methods and non-LEACH protocols. While references[40], [42][43][44] focuses on research on energy efficiency in WSNs, using the SLR method, but with a different protocol from LEACH. Reference [40] discusses the topic of WSN, but does not focus on energy efficiency and does not use SLR. On the other hand, references[39], [45][46][47][48][49][50][51] focuses research on energy efficiency in WSNs, but uses non-SLR methods and develops different protocols from LEACH. The conclusion that can be drawn is that there is no SLR method that focuses on LEACH development. Therefore, the main aim of this research is to fill this knowledge gap.

Table 1. Survei Papers and Observation

Ref. Num	Year	Observation				Protocol
		SLR	LR	Non-SLR	Proposed	
[3]	2017			v	Algorithm/Protocol Model: AQM (Active Queue Management)	Not Leach
[39]	2020			v	Algorithm/Protocol Model: Optimal K-means (OK-means)	Leach Development
[40]	2021	v			explore the IPv6 Routing Protocol for Low Power and Lossy Networks (RPL)	Not Leach
[41]	2022		v		acknowledges the vulnerability of Machine Learning (ML) models to adversarial samples,	Not Leach
[42]	2019		v		provide a comprehensive overview of trajectory optimization for mobile elements in enhancing the performance of Wireless Sensor Networks (WSNs)	Not Leach
[43]	2020		v		investigate and discuss various energy-saving schemes in Wireless Sensor Networks	Not Leach
[44]	2023	v			to investigate routing methods in Flying Ad hoc Network (FANET) utilizing Bio-Inspired Algorithms (BIA), both non-hybrid and hybrid	Not Leach
[45]	2021			v	Algorithm/Protocol Model: Second-Fold Clustering (SFC)	Leach Development
[46]	2022			v	Algorithm/Protocol Model: Sector-Based Lightweight and Flexible Clustering Algorithm	Leach Development
[47]	2018			v	Algorithm/Protocol Model: MA-LEACH (Mobile Aggregator LEACH)	Leach Development
[48]	2017			v	Algorithm/Protocol Model: Mobile CH Nodes, Fixed CH Nodes - Weighted Voronoi Clustering	Leach Development
[49]	2020			v	Algorithm/Protocol Model: Fuzzy Logic based Effective Clustering (FLEC)	Leach Development
[50]	2021			v	Algorithm/Protocol Model: Fuzzy Logic (FL)-Based Clustering Architecture	Leach Development
[51]	2022			v	Algorithm/Protocol Model: EC-DSR with Chicken Swarm Optimization (CSO)	Leach Development
[52]	2023			v	Algorithm/Protocol Model: multihop routing mechanism between the CHs and the base station is constructed by Q-learning	Leach Development

Research Method

The Preferred Reporting Items for Systematic Reviews and Meta-Analyses (PRISMA) statement, published in 2009, was designed to help preparing review reports in a systematic and transparent manner. It was later

strengthened by PRISMA 2020, which confirmed that reporting should include methods of identification, selection, assessment, and study synthesis [53]. To increase transparency, this study adopted an evidence-based search strategy and study selection process. Therefore, to conduct SLR, an open, impartial and fair search strategy must be used. Thus, the search plan must ensure that the search is carried out thoroughly for assessment [54]. To the best of the authors' knowledge, there has been no SLR study that thoroughly investigates and analyzes the current work on the development of the LEACH protocol algorithm for efficient energy consumption in WSNs.

A. Research Desain

In the theoretical basis of SLR proposed by Kitchenham and Charters, strict procedures were introduced that were previously established to guide researchers through the entire study process[55]. This process not only aims to detect bias, errors, and knowledge gaps in the research but also provides direction to areas where additional research might be beneficial. SLR is defined as the process in which researchers identify, evaluate, and synthesize all research relevant to a particular research question, topic area, or phenomenon of interest [55].

According to O.M. Dekkers et al. (2019), there are general procedures that must be followed in creating, conducting, and presenting a systematic review in the field of literature studies[56]. First, researchers need to understand the reasons behind conducting the review and identify questions that need answers. Inclusion and exclusion criteria need to be clearly defined to determine the topic, methods, study design, and methodological quality of the studies to be reviewed. The next step is to design a search strategy to find studies relevant to the research question. The study selection process involves the evaluation of the identified studies in two important stages: evaluation of the title and abstract, followed by evaluation of the full text of the articles that were not excluded in the initial stage. To minimize bias, a minimum of two reviewers were assigned to each stage, with protocols to address discrepancies between them. The next stage involves the use of specific evaluation tools to assess the quality of each study to be included in the review. After that, the process of extracting related data from each study was carried out by two reviewers simultaneously, using a predetermined form. This is followed by a stage involving the analysis and presentation of results using a previously established methodology, including sensitivity analysis if possible. In the final stage, to interpret the results correctly, researchers must consider the limitations of the review and the strength of the evidence found. Additionally, it is important to reflect on how research questions have been answered and identify potential areas for future research.

Briefly, the procedures required in conducting a systematic literature review can be summarized into eight steps: (1) formulating review questions, (2) establishing inclusion and exclusion criteria, (3) searching for related studies, (4) selecting studies to include or exclude, (5) evaluating the quality of studies, (6) extracting related data, (7) summarizing and synthesizing the evidence, and (8) interpreting the findings[57].

B. Research Question

Evidence of actual feasibility is obtained by applying the steps in an actual Systematic Literature Review, in this case an advanced study, which is carried out by formulating a Research Question (RQ)[58]. The aim of this research is to gain a deeper understanding of research efforts that rely on data acquisition within the framework of the LEACH protocol algorithm development for energy consumption

efficiency in WSNs. Therefore, to thoroughly understand this particular research area, an SLR was conducted, which resulted in four Research Questions. The proposed RQ will aid in the classification and understanding of existing literature in this field, as well as highlight barriers and potential avenues for future research in this research area. The following four research questions have been formulated,

1. RQ1: What is the distribution of publications over the last six years?
2. RQ2: What is the geographical scope of the publication?
3. RQ3: What are the research methodologies that have been employed?
4. RQ4: What protocols are necessary to achieve energy-efficient consumption?

C. Search Technique and Selection Criteria

SLR research uses main data sources from six databases, namely IEEEEXPLORE, Springer, Elsevier, ScienceDirect, Taylor & Francis, and MDPI, as seen in Table 2, with selection criteria following the PRISMA flow, as illustrated in Figure 3, Selection Flow Diagram PRISMA Articles. This research specifically considered English-language articles published in the last six years, specifically between January 2017 and February 2023. The search strategy used involved the application of specific keywords and search operators, namely (“Wireless Sensor Networks” OR “WSN”) AND (“Energy Consumption” AND (“efficient” OR “saving”) AND/OR (“study literature review” OR “SLR”) AND/OR (“Low Energy Adaptive Clustering Hierarchy” OR “LEACH”).

Table 2. Database Source of 2017-2023

Num	Database Source	Web Site	Leach development								
			SLR			Review, Survey, Literature			non-SLR		
			Journals	Conferences	Books	Journals	Conferences	Books	Journals	Conferences	Books
1	ieeexplore	https://ieeexplore.ieee.org/Xplore/home.jsp	0	0	0	7	13	0	46	325	0
2	Springer	https://link.springer.com/	0	0	0	5	9	11	3	9	11
3	Elsevier	https://www.elsevier.com/	0	0	0	79	105	456	137	25	1743
4	ScienceDirect	https://www.sciencedirect.com/	0	0	0	7	1	0	47	14	1
5	tandfonline	https://www.tandfonline.com/	0	0	0	43	9	5	86	9	5
6	MDPI	https://www.mdpi.com/	0	0	0	185	36	1	286	37	1
Total			3757								

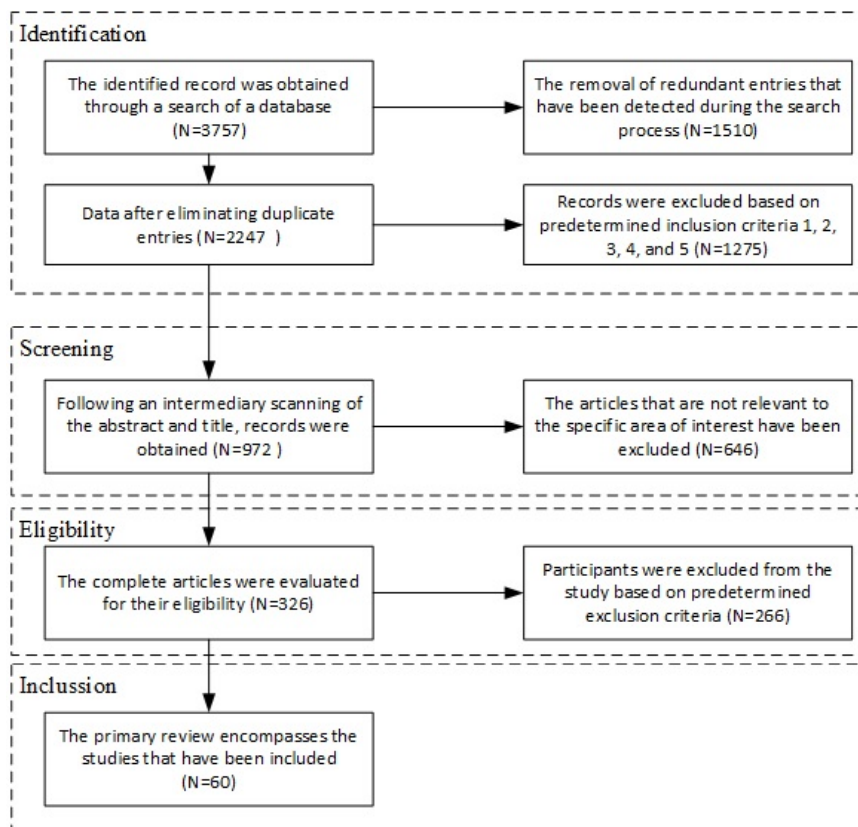

Fig. 3. Article Selection Flow Diagram

Table 2: Database exploration yielded 3755 identifications, with IEEEEXPLORE at 391, Springer 48, Elsevier 2545, ScienceDirect 70, tandfonline 157, and MDPI 546. Prior to the filtering process, a thorough check of the records was carried out to ensure that no redundant data was extracted from the database. Deletion was carried out for 1510 articles that were detected as redundant data entries during the search process. An additional 1275 records were excluded due to the unavailability of full text after the application of inclusion and exclusion criteria. In the screening process,

after scanning the abstracts and titles, a total of 972 articles were obtained. However, there were 646 articles that were deemed irrelevant to the topic and were then excluded, so at the eligibility stage, there were 326 articles that met the requirements. An additional 266 articles were excluded because they did not meet the correct inclusion criteria or were not relevant to the scope of the investigation. After the initial screening process, a total of 60 articles were deemed eligible for further examination and follow-up analysis, as described in the results section, which is displayed in Figure 3.

D. Inclusion and Exclusion Criteria

Figure 3 depicts the article selection process based on the PRISMA framework, which involved a comprehensive record search for these SLRs. The search and selection of articles in this survey involved inclusion (IC) and exclusion (EC) criteria to facilitate the selection of related studies from available data sources. The established criteria are applied uniformly to all studies collected during the various phases of the Article Selection Flow Diagram (ASFD). The data collection period was set from January 2017 to February 2023, spanning a decade, to ensure the inclusion of only recent studies during the search process. Additionally, we have included cited studies at an early stage, provided the full text of the study is accessible. Table 3 presents the IC and EC criteria used in this systematic literature review to identify relevant studies. These criteria were used during the screening and eligibility phases of the ASFD, as illustrated in Figure 3. During the screening phase, the KI and KE criteria were applied to the title, keywords, abstract, and conclusion of the study. The results of the IC and EC processes are shown in Table 3 below:

Table 3. Inclusion and Exclusion Criteria

No.	Inclusion	Exclusion
1.	Publication must be written in English.	The article isn't written in English.
2.	The article was published between 2017 and 2023.	The article is duplicated.
3.	The article is based on journal, proceeding, and book.	The article can't be downloaded in a full text.
4.	The study is focused on energy consumption on WSN, with the main outline on the protocol LEACH algorithm development.	The article isn't focused on energy consumption on WSN.
5.	The article study from full text.	Article that has no clear result.

Results

The research questions have been prepared, and this section will explain in detail the discussion regarding WSN, energy consumption efficiency, and the development of the LEACH protocol algorithm in its role in answering the research questions.

A. Distribution of Publications Over The Last Six Years

Figure 4 shows a literature analysis for the period 2017 to 2023, with a focus on studies on the theme of energy consumption in Wireless Sensor Networks that use the Leach development protocol, related to Leach, and not related to Leach. In 2017, one journal was found relevant to the topic, while in 2018, three journals were found. 2019 saw the discovery of two related journals, indicating continued interest in the research. A significant increase was seen in 2020 and 2021, with eight journals published in each. This marks an intensification phase in understanding and exploring energy consumption in WSNs by implementing the Leach protocol. In 2022, the number of journals found remains significant, namely five journals, reflecting the continuation of research interest despite a significant decline. It is important to note that as of September 2023, nine related journals have been identified. Assuming that one journal is published every month on the same topic, projections for the entire year 2023 show the potential for publication of 12 journals. This marks the peak of publication activity and confirms the significance of the contribution to the understanding of energy consumption in WSNs with a focus on the Leach protocol.

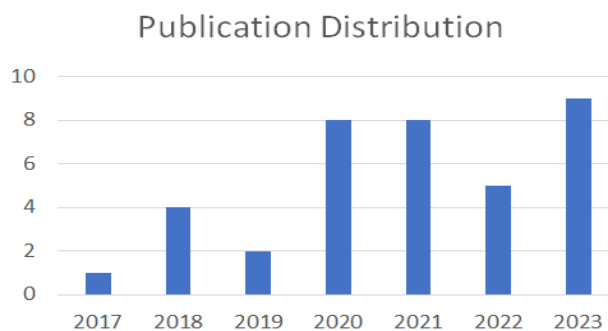

Fig. 4. Distribution of Publications during the period 2017 – 2023

B. The Geographical Scope of The Studies

Based on Figure 5, the nine countries with the highest level of activity in this field of study are presented. The reason why these nine countries are considered the top is because they are countries that conducted two or more studies. In total, 20 countries were identified as currently active. Twenty studies were conducted by India, eight by the United Kingdom, seven by China, three by Egypt and Malaysia, two by Saudi Arabia, Algeria, Australia and Indonesia. Meanwhile, countries such as Canada, Iran, Ireland, Italy, Korea, South Korea, the Netherlands, Spain, Morocco, Thailand and the United States each have one study. According to the findings presented in Figure 5, India shows the highest level of activity.

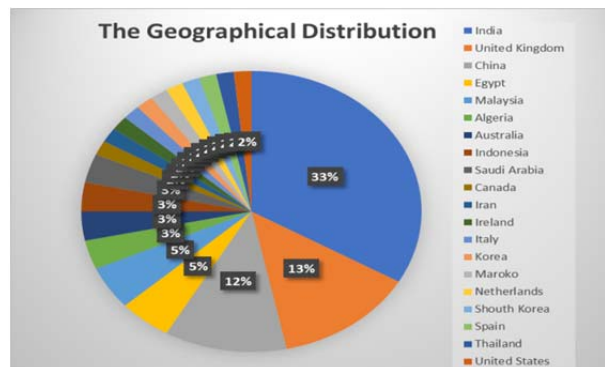

Fig. 5. The Geographical Distribution

C. The Research Methodologies

The research methodology was implemented to evaluate and analyze existing articles with the aim of grouping them based on the type of method applied by the researcher. The evaluation results show that most studies in the domain of energy consumption efficiency in Wireless Sensor Networks (WSN) were carried out using various methods, such as experimental, combination, Systematic Literature Review (SLR), theory, surveys and reviews. The use of the term "combined methods" is applied because many studies adopt more than one method in one study. For example, some studies combine experimental methods with surveys, literature, or simulations. This classification refers to data taken from the references presented, and to provide better readability, coding is applied to each reference. For example, the first reference is denoted as R1, the second reference as R2, and so on. The collected research results are then presented in graphical form in Figure 6 and tables in Table 4 to provide a clearer and more structured view. The results show that the experimental method has 37 publications, the combined method has 6 publications, the SLR method has 5 publications, the survey method has 4 publications, and the review method has 3 publications

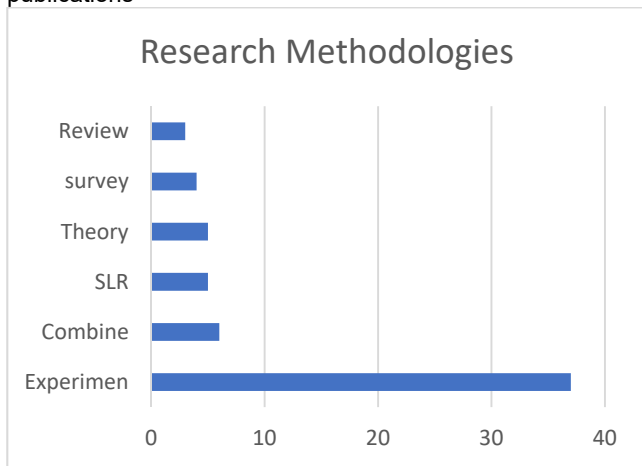

Fig. 6. Research Methodologies

Table 4. Research Methodologies

Research Methodologies	Number	References
Experiment	37	R8, R11, R23, R29-R36, R38, R44-46, R48-R51, R58-74
Combined	6	R1, R3, R27, R28, R40, R75
SLR	5	R4, R39, R43, R53, R54
Theory	5	R24, R25, R47, R52, R57
survey	4	R2, R41, R42, R76
Review	3	R26, R55, R57

D. The Protocols Energy- Efficient Consumption

Innovation in the development of energy consumption protocols in WSN greatly determines the level of efficiency, which has an impact on network longevity. To fully understand the contribution of protocol development in terms of the evaluation mechanisms used by the selected studies, we describe and classify the development protocols identified in the process of reviewing the literature on routing protocol development implementations used by the researchers. The research results are presented in Table 5 below.

Table 5. Protocol development

Ref.	Protocol Development	Basic Protocol
[9]	MDC-TSP-LEACH-K	Leach
[12]	LEACH	Leach
[24]	APAC, LEACH, DLMP	Leach
[25]	Routing Protocol	related Leach
[31]	DTC-BR, MCCA, LEACH-MEEC,	Leach
[32]	HFAPSO	Leach
[33]	I-Leach	Leach
[34]	SILEACH	Leach
[35]	F5NUCP, TEEN, LEACH	Leach
[36]	Leach DEEC	Leach
[37]	K-Means, TSP, MDC-LEACH	Leach
[38]	FL-Leach, PSO	Leach
[39]	K-Means Clustering	related Leach
[45]	SFC, R-LEACH	Leach
[46]	LEACH, TSC, MHTSC	Leach
[47]	MA-LEACH	Leach
[48]	CVT	related Leach
[49]	FLEC, LEACH-Fuzzy	Leach
[50]	MOFCA, FLDFUCF, EUCF	Leach
[51]	IJO-LF, IOCA, PEGASIS	not Leach
[52]	Q-Learning, ACA-Leach	Leach
[59]	SEP, DEEC,	Leach
[60]	Q-EBIoT	not Leach
[61]	UAVs,	Leach
[62]	HEWSN, TLM, MOPSO	Leach
[63]	Fuzzy-Logic	not Leach
[64]	PEGCP	Leach
[65]	FEBUCA, TM-ORT	not Leach
[66]	HEUC, EBULRP, AECR	not Leach
[67]	ACO, NPPRN, ECRC-UCA	related Leach
[68]	CSO-UCRA	related Leach
[69]	E-FUCA	related Leach
[70]	Fuzzy-Logic	Leach
[71]	ESCVAD	Leach
[72]	HMGear-Leach	Leach
[73]	MFPC-Leach	Leach
[74]	W-Leach	Leach
[75]	HEED	not Leach

Table 5. It can be simplified in figure 7 as below,

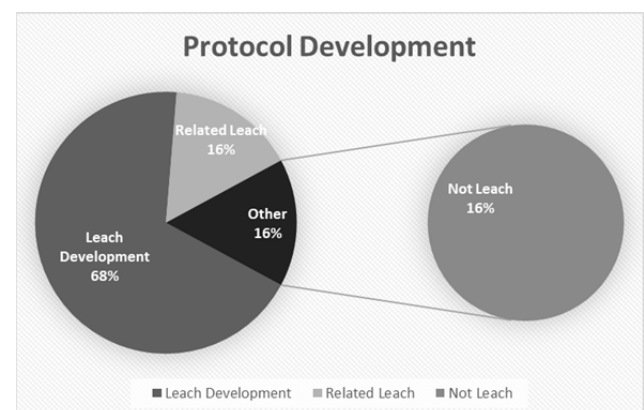

Fig. 7. Protocol development

Figure 7 provides information about the results of a literature study on the theme of efficient energy consumption in the WSN field, showing that there are 68% LEACH development protocols, 16% of protocols are related to the LEACH protocol, and 16% of protocols are not related to the LEACH protocol.

Conclusions

This research effort involved conducting a systematic literature review (SLR) that provided a comprehensive review of the existing literature regarding energy consumption data collection in WSNs over a ten-year period from 2017 to 2023. A total of 3757 papers were initially retrieved from the search. Furthermore, 2247 papers were selected after thorough analysis. Of the 2247 papers, 972 studies were selected based on established IC and EC criteria, and the final inclusion result was 60 papers. This study reveals that research in this area is relatively recent, with a consistent and moderate number of publications in the last half decade. With this level of consistency, it is anticipated that there will be an increase in contributions regarding the proposal in the next few years. Additionally, it is critical for researchers to consider research challenges and future research directions to address those challenges.

This article presents a systematic literature review (SLR) on environmental energy consumption data collection in WSNs. Energy consumption data collection in WSNs has attracted significant interest among researchers over the last decade. Currently, it is urgently necessary to acquire sensor data from sensor devices that have network lifetime endurance. This section provides a summary and discussion of the results related to the research questions. Research findings, challenges encountered during the research, and potential directions for future research are presented. The main aim of this systematic literature review (SLR) is to analyze the existing literature in the area of investigation. To accomplish this task, a total of 75 studies were selected for analysis based on the methodology described in the Research Methods Section. Therefore, a thorough analysis and synthesis of the selected studies was conducted to help resolve the research questions, as presented in Figure 3. The main results of this Systematic Literature Review (SLR) are described as follows. Examination of the demographics of the selected studies reveals a degree of stability, as is evident from consistent publication output over the past six years, despite an assumed upward trend. From the Geographic Space study, it can be seen that there are 11 active countries, nine countries with high levels of activity, with India as the most active country reaching 33%. The research methodology shows that the experimental method has the highest percentage, namely 68%.

Acknowledgment

This paper will be financially supported by my institution, Malang State Polytechnic.

Authors

Drs. Yoyok Heru Prasetyo ISNOMO, MT., Electrical Engineering, Malang State Polytechnic, Jl Soekarno-Hatta No.9, Malang, Jawa Timur, Indonesia; E-mail : yoyok.heru@polinema.ac.id ; Dr. MULADI, Electrical and informatics Engineering Study Program, Malang State University, Indonesia, Jl. Semarang 5 Malang, Jawa Timur, Indonesia; E-mail : muladi@um.ac.id ; Prof., Dr. Hakkun ELMUNSYAH, Electrical and informatics Engineering Study Program, Malang State University, Indonesia, Jl. Semarang 5 Malang, Jawa Timur, Indonesia; E-mail: hakkun@um.ac.id.

REFERENCES

- [1] A. Ali, Y. K. Jadoon, S. A. Changazi, and M. Qasim, "Military Operations: Wireless Sensor Networks based Applications to Reinforce Future Battlefield Command System," *Proc. - 2020 23rd IEEE Int. Multi-Topic Conf. INMIC 2020*, 2020, doi: 10.1109/INMIC50486.2020.9318168.
- [2] T. Rajasekaran and S. Anandamurugan, *Challenges and Applications of Wireless Sensor Networks in Smart Farming—A Survey*, vol. 750. Springer Singapore, 2019. doi: 10.1007/978-981-13-1882-5_30.
- [3] A. A. Rezaee and F. Pasandideh, "A Fuzzy Congestion Control Protocol Based on Active Queue Management in Wireless Sensor Networks with Medical Applications," *Wirel. Pers. Commun.*, vol. 98, no. 1, pp. 815–842, 2018, doi: 10.1007/s11277-017-4896-6.
- [4] A. Lavric and V. Popa, "Performance evaluation of routing algorithms used in large- scale wsn: A step towards a smart city," *Prz. Elektrotechniczny*, vol. 91, no. 8, pp. 96–100, 2015, doi: 10.15199/48.2015.08.24.
- [5] M. Majid *et al.*, "Applications of Wireless Sensor Networks and Internet of Things Frameworks in the Industry Revolution 4.0: A Systematic Literature Review," *Sensors*, vol. 22, no. 6, pp. 1–36, 2022, doi: 10.3390/s22062087.
- [6] M. Elshrkawey, S. M. Elsherif, and M. Elsayed Wahed, "An Enhancement Approach for Reducing the Energy Consumption in Wireless Sensor Networks," *J. King Saud Univ. - Comput. Inf. Sci.*, vol. 30, no. 2, pp. 259–267, 2018, doi: 10.1016/j.jksuci.2017.04.002.
- [7] E. A. Evangelakos, D. Kandris, D. Rountos, G. Tselikis, and E. Anastasiadis, "Energy Sustainability in Wireless Sensor Networks: An Analytical Survey," *J. Low Power Electron. Appl.*, vol. 12, no. 4, 2022, doi: 10.3390/jlpea12040065.
- [8] O. Younis and S. Fahmy, "Distributed clustering in ad-hoc sensor networks: A hybrid, energy-efficient approach," *Proc. - IEEE INFOCOM*, vol. 1, pp. 629–640, 2004, doi: 10.1109/infcom.2004.1354534.
- [9] R. Gantassi, B. Ben Gouissem, O. Cheikhrouhou, S. El Khediri, and S. Hasnaoui, "Optimizing Quality of Service of Clustering Protocols in Large-Scale Wireless Sensor Networks with Mobile Data Collector and Machine Learning," *Secur. Commun. Networks*, vol. 2021, 2021, doi: 10.1155/2021/5531185.
- [10] F. H. El-Fouly, M. Kachout, Y. Alharbi, J. S. Alshudukhi, A. Alanazi, and R. A. Ramadan, "Environment-Aware Energy Efficient and Reliable Routing in Real-Time Multi-Sink Wireless Sensor Networks for Smart Cities Applications," *Appl. Sci.*, vol. 13, no. 1, 2023, doi: 10.3390/app13010605.
- [11] R. Mahakud *et al.*, "Energy Management in Wireless Sensor Network Using PEGASIS," *Procedia Comput. Sci.*, vol. 92, pp. 207–212, 2016, doi: 10.1016/j.procs.2016.07.347.
- [12] W. R. Heinzelman, A. Chandrakasan, and H. Balakrishnan, "Energy-efficient communication protocol for wireless microsensor networks," *Proc. Annu. Hawaii Int. Conf. Syst. Sci.*, vol. 2000-Janua, no. c, pp. 1–10, 2000.
- [13] I. Daanoune, B. Abdennaceur, and A. Ballouk, "A comprehensive survey on LEACH-based clustering routing protocols in Wireless Sensor Networks," *Ad Hoc Networks*, vol. 114, no. January, p. 102409, 2021, doi: 10.1016/j.adhoc.2020.102409.
- [14] Moorthi and R. Thiagarajan, "Energy consumption and network connectivity based on Novel-LEACH-POS protocol networks," *Comput. Commun.*, vol. 149, no. June 2019, pp. 90–98, 2020, doi: 10.1016/j.comcom.2019.10.006.
- [15] F. Zhang, Z. Yin, A. Gu, Y. Li, and H. Liu, "Research on simulation of cluster routing protocol for industrial wireless sensor networks," *2018 IEEE 4th Int. Conf. Comput. Commun. ICC 2018*, pp. 265–269, 2018, doi: 10.1109/CompComm.2018.8780600.
- [16] M. Farsi, M. Badawy, M. Moustafa, H. A. Arafat, and Y. Abdulazeem, "A Congestion-Aware Clustering and Routing (CCR) Protocol for Mitigating Congestion in WSN," *IEEE Access*, vol. 7, pp. 105402–105419, 2019, doi: 10.1109/ACCESS.2019.2932951.
- [17] I. Kaushik and N. Sharma, *Black Hole Attack and Its Security Measure in Wireless Sensors Networks*, vol. 1132. 2020. doi: 10.1007/978-3-030-40305-8_20.
- [18] L. K. Ketshabetswe, A. M. Zungeru, M. Mangwala, J. M. Chuma, and B. Sigweni, "Communication protocols for wireless sensor networks: A survey and comparison," *Heliyon*, vol. 5, no. 5, p. e01591, 2019, doi: 10.1016/j.heliyon.2019.e01591.
- [19] Y. Ge, S. Wang, and J. Ma, "Optimization on TEEN routing protocol in cognitive wireless sensor network," *Eurasip J. Wirel. Commun. Netw.*, vol. 2018, no. 1, 2018, doi: 10.1186/s13638-018-1039-z.
- [20] R. P. Mahapatra and R. K. Yadav, "Descendant of LEACH Based Routing Protocols in Wireless Sensor Networks," *Procedia Comput. Sci.*, vol. 57, pp. 1005–1014, 2015, doi: 10.1016/j.procs.2015.07.505.
- [21] L. Zhao, S. Qu, and Y. Yi, "A modified cluster-head selection algorithm in wireless sensor networks based on LEACH,"

- Eurasip J. Wirel. Commun. Netw.*, vol. 2018, no. 1, 2018, doi: 10.1186/s13638-018-1299-7.
- [22] J. Chu and W. Han, "Internet Communication System Protocol Based on Wireless Sensor," *Radioelectron. Commun. Syst.*, vol. 62, no. 8, pp. 422–429, 2019, doi: 10.3103/S0735272719080065.
- [23] H. Liang, S. Yang, L. Li, and J. Gao, "Research on routing optimization of WSNs based on improved LEACH protocol," *Eurasip J. Wirel. Commun. Netw.*, vol. 2019, no. 1, 2019, doi: 10.1186/s13638-019-1509-y.
- [24] H. Upadhyay and M. Mehta, "Improved APAC algorithm for minimizing delay in wireless sensor network with mobile sink," *Int. J. Adv. Comput. Res.*, vol. 7, no. 28, pp. 23–31, 2017, doi: 10.19101/IJACR.2016.627001.
- [25] P. Maratha and K. Gupta, "A comprehensive and systematized review of energy-efficient routing protocols in wireless sensor networks," *Int. J. Comput. Appl.*, vol. 44, no. 1, pp. 83–100, 2019, doi: 10.1080/1206212X.2019.1697513.
- [26] N. Chauhan and S. Chauhan, "Partly Centralized Partly Distributed Energy Efficient Sleep/Wake Scheduling in Wireless Sensor Networks for Applications Requiring Continuous Sensing," *IETE Tech. Rev. (Institution Electron. Telecommun. Eng. India)*, vol. 39, no. 4, pp. 940–952, 2022, doi: 10.1080/02564602.2021.1934906.
- [27] M. A. Jamshed, K. Ali, Q. H. Abbasi, M. A. Imran, and M. Ur-Rehman, "Challenges, Applications, and Future of Wireless Sensors in Internet of Things: A Review," *IEEE Sens. J.*, vol. 22, no. 6, pp. 5482–5494, 2022, doi: 10.1109/JSEN.2022.3148128.
- [28] B. N. Silva, M. Khan, and K. Han, "Internet of Things: A Comprehensive Review of Enabling Technologies, Architecture, and Challenges," *IETE Tech. Rev. (Institution Electron. Telecommun. Eng. India)*, vol. 35, no. 2, pp. 205–220, 2018, doi: 10.1080/02564602.2016.1276416.
- [29] S. Selvan, M. Zaman, R. Gobbi, and H. Y. Wong, "Recent advances in the design and development of radio frequency-based energy harvester for powering wireless sensors: a review," *J. Electromagn. Waves Appl.*, vol. 32, no. 16, pp. 2110–2134, 2018, doi: 10.1080/09205071.2018.1497548.
- [30] E. M. Manuel, V. Pankajakshan, and M. T. Mohan, "Efficient Strategies for Signal Aggregation in Low-Power Wireless Sensor Networks With Discrete Transmission Ranges," *IEEE Sensors Lett.*, vol. 7, no. 3, pp. 5–8, 2023, doi: 10.1109/LSENS.2023.3250432.
- [31] M. E. Al-Sadoon, A. Jedidi, and H. Al-Raweshidy, "Dual-Tier Cluster-Based Routing in Mobile Wireless Sensor Network for IoT Application," *IEEE Access*, vol. 11, no. January, pp. 4079–4094, 2023, doi: 10.1109/ACCESS.2023.3235200.
- [32] B. Pitchaimanickam and G. Murugaboopathi, "A hybrid firefly algorithm with particle swarm optimization for energy efficient optimal cluster head selection in wireless sensor networks," *Neural Comput. Appl.*, vol. 32, no. 12, pp. 7709–7723, 2020, doi: 10.1007/s00521-019-04441-0.
- [33] S. Jain and N. Agrawal, "Development of Energy Efficient Modified LEACH Protocol for IoT Applications," *Proc. - 2020 12th Int. Conf. Comput. Intell. Commun. Networks, CICN 2020*, pp. 160–164, 2020, doi: 10.1109/CICN49253.2020.9242619.
- [34] A. S. Al-Zubaidi, A. A. Ariffin, and A. K. Al-Qadhi, "Enhancing the stability of the improved-leach routing protocol for wsns," *J. ICT Res. Appl.*, vol. 12, no. 1, pp. 1–13, 2018, doi: 10.5614/itbj.ict.res.appl.2018.12.1.1.
- [35] S. Arjunan, S. Pothula, and D. Ponnurangam, "F5N-based unequal clustering protocol (F5NUCP) for wireless sensor networks," *Int. J. Commun. Syst.*, vol. 31, no. 17, pp. 1–14, 2018, doi: 10.1002/dac.3811.
- [36] Y. Chen, C. Shen, K. Zhang, H. Wang, and Q. Gao, "LEACH Algorithm based on energy consumption equilibrium," *Proc. - 3rd Int. Conf. Intell. Transp. Big Data Smart City, ICITBS 2018*, vol. 2018-Janua, pp. 677–680, 2018, doi: 10.1109/ICITBS.2018.00176.
- [37] R. Gantassi, Z. Masood, and Y. Choi, "Enhancing QoS and Residual Energy by Using of Grid-Size Clustering, K-Means, and TSP Algorithms With MDC in LEACH Protocol," *IEEE Access*, vol. 10, pp. 58199–58211, 2022, doi: 10.1109/ACCESS.2022.3178434.
- [38] M. Gamal, N. E. Mekky, H. H. Soliman, and N. A. Hikal, "Enhancing the Lifetime of Wireless Sensor Networks Using Fuzzy Logic LEACH Technique-Based Particle Swarm Optimization," *IEEE Access*, vol. 10, pp. 36935–36948, 2022, doi: 10.1109/ACCESS.2022.3163254.
- [39] S. El Khediri, W. Fakhet, T. Moulahi, R. Khan, A. Thaljaoui, and A. Kachouri, "Improved node localization using K-means clustering for Wireless Sensor Networks," *Comput. Sci. Rev.*, vol. 37, p. 100284, 2020, doi: 10.1016/j.cosrev.2020.100284.
- [40] A. M. Pasikhani, J. A. Clark, P. Gope, and A. Alshahrani, "Intrusion Detection Systems in RPL-Based 6LoWPAN: A Systematic Literature Review," *IEEE Sens. J.*, vol. 21, no. 11, pp. 12940–12968, 2021, doi: 10.1109/JSEN.2021.3068240.
- [41] J. Liu, M. Nogueira, J. Fernandes, and B. Kantarci, "Adversarial Machine Learning: A Multilayer Review of the State-of-the-Art and Challenges for Wireless and Mobile Systems," *IEEE Commun. Surv. Tutorials*, vol. 24, no. 1, pp. 123–159, 2022, doi: 10.1109/COMST.2021.3136132.
- [42] S. K. Singh and P. Kumar, "A comprehensive survey on trajectory schemes for data collection using mobile elements in WSNs," *J. Ambient Intell. Humaniz. Comput.*, vol. 11, no. 1, pp. 291–312, 2020, doi: 10.1007/s12652-019-01268-4.
- [43] S. M. Chowdhury and A. Hossain, "Different Energy Saving Schemes in Wireless Sensor Networks: A Survey," *Wirel. Pers. Commun.*, vol. 114, no. 3, pp. 2043–2062, 2020, doi: 10.1007/s11277-020-07461-5.
- [44] T. R. Beegum, M. Y. I. Idris, M. N. Bin Ayub, and H. A. Shehadeh, "Optimized Routing of UAVs Using Bio-Inspired Algorithm in FANET: A Systematic Review," *IEEE Access*, vol. 11, no. February, pp. 15588–15622, 2023, doi: 10.1109/ACCESS.2023.3244067.
- [45] V. Vimal *et al.*, "Clustering Isolated Nodes to Enhance Network's Life Time of WSNs for IoT Applications," *IEEE Syst. J.*, vol. 15, no. 4, pp. 5654–5663, 2021, doi: 10.1109/JSYST.2021.3103696.
- [46] B. Zeng, C. Zhao, Y. Zhang, J. Sun, and X. Gao, "A Sector-Based Energy-Efficient Lightweight Clustering Algorithm," *IEEE Access*, vol. 10, no. September, pp. 108285–108295, 2022, doi: 10.1109/ACCESS.2022.3213826.
- [47] A. Elsayed and M. Sharaf, "MA-LEACH: Energy Efficient Routing Protocol for WSNs using Particle Swarm Optimization and Mobile Aggregator," *Int. J. Comput. Networks Appl.*, vol. 5, no. 1, p. 1, 2018, doi: 10.22247/ijcna/2018/49344.
- [48] A. Pietrabbissa and F. Liberati, "Dynamic distributed clustering in wireless sensor networks via Voronoi tessellation control," *Int. J. Control*, vol. 92, no. 5, pp. 1001–1014, 2019, doi: 10.1080/00207179.2017.1378441.
- [49] A. Verma, S. Kumar, P. R. Gautam, T. Rashid, and A. Kumar, "Fuzzy Logic Based Effective Clustering of Homogeneous Wireless Sensor Networks for Mobile Sink," *IEEE Sens. J.*, vol. 20, no. 10, pp. 5615–5623, 2020, doi: 10.1109/JSEN.2020.2969697.
- [50] S. Phoemphon, C. So-In, P. Aimtongkham, and T. G. Nguyen, "An energy-efficient fuzzy-based scheme for unequal multihop clustering in wireless sensor networks," *J. Ambient Intell. Humaniz. Comput.*, vol. 12, no. 1, pp. 873–895, 2021, doi: 10.1007/s12652-020-02090-z.
- [51] R. Vinodha, S. Durairaj, and S. Padmavathi, "Energy-efficient routing protocol and optimized passive clustering in WSN for SMART grid applications," *Int. J. Commun. Syst.*, vol. 35, no. 1, pp. 1–18, 2022, doi: 10.1002/dac.5019.
- [52] Y. Di Yao *et al.*, "Multihop Clustering Routing Protocol Based on Improved Coronavirus Herd Immunity Optimizer and Q-Learning in WSNs," *IEEE Sens. J.*, vol. 23, no. 2, pp. 1645–1659, 2023, doi: 10.1109/JSEN.2022.3225956.
- [53] M. J. Page *et al.*, "The PRISMA 2020 statement: an updated guideline for reporting systematic reviews," *Syst. Rev.*, vol. 10, no. 1, pp. 1–11, 2021, doi: 10.1186/s13643-021-01626-4.
- [54] A. S. Ghiduk, M. R. Girgis, and M. H. Shehata, "Higher order mutation testing: A Systematic Literature Review," *Comput. Sci. Rev.*, vol. 25, pp. 29–48, 2017, doi: 10.1016/j.cosrev.2017.06.001.
- [55] B. A. Kitchenham and S. Charters, "Guidelines for performing Systematic Literature Reviews in Software Engineering (Software Engineering Group, Department of Computer Science, Keele ...," *Tech. Rep. EBSE 2007- 001. Keele Univ. Durham Univ. Jt. Rep.*, no. January, 2007.
- [56] W. W. Wang *et al.*, "Introduction to COSMOS-E: Guidance on conducting systematic reviews and Meta-analyses on etiology of observational studies," *Zhonghua Liu Xing Bing Xue Za Zhi*, vol. 41, no. 12, pp. 2149–2159, 2020, doi:

- 10.3760/cma.j.cn112338-20191024-00758.
- [57] G. Lame, "Systematic literature reviews: An introduction," *Proc. Int. Conf. Eng. Des. ICED*, vol. 2019-Augus, no. August, pp. 1633–1642, 2019, doi: 10.1017/dsi.2019.169.
- [58] J. Pérez, J. Díaz, J. Garcia-Martin, and B. Tabuenca, "Systematic literature reviews in software engineering—enhancement of the study selection process using Cohen's Kappa statistic," *J. Syst. Softw.*, vol. 168, p. 110657, 2020, doi: 10.1016/j.jss.2020.110657.
- [59] T. M. Behera, S. K. Mohapatra, U. C. Samal, M. S. Khan, M. Daneshmand, and A. H. Gandomi, "I-SEP: An Improved Routing Protocol for Heterogeneous WSN for IoT-Based Environmental Monitoring," *IEEE Internet Things J.*, vol. 7, no. 1, pp. 710–717, 2020, doi: 10.1109/JIOT.2019.2940988.
- [60] S. Kumar, O. Kaiwartya, M. Rathee, N. Kumar, and J. Lloret, "Toward Energy-Oriented Optimization for Green Communication in Sensor Enabled IoT Environments," *IEEE Syst. J.*, vol. 14, no. 4, pp. 4663–4673, 2020, doi: 10.1109/JSYST.2020.2975823.
- [61] J. Gu, H. Wang, G. Ding, Y. Xu, Z. Xue, and H. Zhou, "Energy-constrained completion time minimization in UAV-enabled internet of things," *IEEE Internet Things J.*, vol. 7, no. 6, pp. 5491–5503, 2020, doi: 10.1109/JIOT.2020.2981092.
- [62] Y. Xiong, G. Chen, M. Lu, X. Wan, M. Wu, and J. She, "A Two-Phase Lifetime-Enhancing Method for Hybrid Energy-Harvesting Wireless Sensor Network," *IEEE Sens. J.*, vol. 20, no. 4, pp. 1934–1946, 2020, doi: 10.1109/JSEN.2019.2948620.
- [63] T. Stephan, K. Sharma, A. Shankar, S. Punitha, V. Varadarajan, and P. Liu, "Fuzzy-Logic-Inspired Zone-Based Clustering Algorithm for Wireless Sensor Networks," *Int. J. Fuzzy Syst.*, vol. 23, no. 2, pp. 506–517, 2021, doi: 10.1007/s40815-020-00929-3.
- [64] F. Bouakkaz and M. Derdour, "Maximizing WSN Life Using Power Efficient Grid-Chain Routing Protocol (PEGCP)," *Wirel. Pers. Commun.*, vol. 117, no. 2, pp. 1007–1023, 2021, doi: 10.1007/s11277-020-07908-9.
- [65] V. Rajaram and N. Kumarathan, "Multi-hop optimized routing algorithm and load balanced fuzzy clustering in wireless sensor networks," *J. Ambient Intell. Humaniz. Comput.*, vol. 12, no. 3, pp. 4281–4289, 2021, doi: 10.1007/s12652-020-01827-0.
- [66] N. M. Shagari, M. Y. I. Idris, R. Bin Salleh, I. Ahmady, G. Murtaza, and A. Q. B. M. Sabri, "A hybridization strategy using equal and unequal clustering schemes to mitigate idle listening for lifetime maximization of wireless sensor network," *Wirel. Networks*, vol. 27, no. 4, pp. 2641–2670, 2021, doi: 10.1007/s11276-021-02608-z.
- [67] N. Moussa and A. El Belrhiti El Alaoui, "An energy-efficient cluster-based routing protocol using unequal clustering and improved ACO techniques for WSNs," *Peer-to-Peer Netw. Appl.*, vol. 14, no. 3, pp. 1334–1347, 2021, doi: 10.1007/s12083-020-01056-4.
- [68] P. C. S. Rao, P. Lalwani, H. Banka, and G. S. N. Rao, "Competitive swarm optimization based unequal clustering and routing algorithms (CSO-UCRA) for wireless sensor networks," *Multimed. Tools Appl.*, vol. 80, no. 17, pp. 26093–26119, 2021, doi: 10.1007/s11042-021-10901-4.
- [69] X. S. Mehra, "E-FUCA: enhancement in fuzzy unequal clustering and routing for sustainable wireless sensor network," *Complex Intell. Syst.*, vol. 8, no. 1, pp. 393–412, 2022, doi: 10.1007/s40747-021-00392-z.
- [70] X. Liu, J. Yu, W. Zhang, and H. Tian, "Low-energy dynamic clustering scheme for multi-layer wireless sensor networks," *Comput. Electr. Eng.*, vol. 91, no. March, p. 107093, 2021, doi: 10.1016/j.compeleceng.2021.107093.
- [71] N. Ma, H. Zhang, H. Hu, and Y. Qin, "ESCVAD: An Energy-Saving Routing Protocol Based on Voronoi Adaptive Clustering for Wireless Sensor Networks," *IEEE Internet Things J.*, vol. 9, no. 11, pp. 9071–9085, 2022, doi: 10.1109/JIOT.2021.3120744.
- [72] Z. A. Khan, S. Amjad, F. Ahmed, A. M. Almasoud, M. Imran, and N. Javaid, "A Blockchain-Based Deep-Learning-Driven Architecture for Quality Routing in Wireless Sensor Networks," *IEEE Access*, vol. 11, no. February, pp. 31036–31051, 2023, doi: 10.1109/ACCESS.2023.3259982.
- [73] I. Raziah, Y. Yunida, Y. Away, R. Muharar, and N. Nasaruddin, "A New Adaptive Power Control Based on LEACH Clustering Protocol for Interference Management in Cooperative D2D Systems," *IEEE Access*, vol. 10, no. November, pp. 113513–113522, 2022, doi: 10.1109/ACCESS.2022.3217219.
- [74] S. A. Chafi, H. Abbad, M. K. Benhaoua, and A. El Hassan Benyamina, "Improvement of LEACH Protocol: W-LEACH Approach," *Int. Conf. Smart Comput. Appl. ICSCA 2023*, 2023, doi: 10.1109/ICSCA57840.2023.10087572.
- [75] C. H. Lin and M. J. Tsai, "A comment on 'HEED: A Hybrid, Energy-Efficient, Distributed clustering approach for ad hoc sensor networks,'" *IEEE Trans. Mob. Comput.*, vol. 5, no. 10, pp. 1471–1472, 2006, doi: 10.1109/TMC.2006.141.