

doi:10.15199/48.2020.12.45

## Determinants of HPEM and HPM signal environmental measurements

**Streszczenie.** W artykule przedstawiono najczęściej spotykane (główne) przeszkody, które wymagają szczególnych rozwiązań układowych oraz zastosowania nietypowych metod pomiarowych, w celu wykonania poprawnych, metrologicznie wiarygodnych pomiarów parametrów i charakterystyk impulsowych pól EM wielkiej mocy w warunkach środowiskowych. (Metody pomiaru elektromagnetycznych pól impulsowych dużej mocy)

**Abstract:** The article reviews the most common (main) obstacles, which require specific layout solutions, as well as application of non-standard measuring methods in order to conduct correct and metrologically reliable measurements of parameters and pulse characteristics of high-power EM fields in environmental conditions.

**Słowa kluczowe:** impulsy HPEM, HPM, metody pomiarowe, pomiary środowiskowe

**Keywords:** HPEM pulses, HPM, measuring method, measurement environment

### Introduction

Most contemporary European armies are equipped with weapons utilizing directed-energy weapons (E-bombs). They are characterized by generating pulsed radiation of extremely high power (even in the order of GW), able to destroy electronic devices. In such a case, unprotected military electronic devices can be easily destroyed. Portable or mobile pulse generators are also available. The aforementioned high-power electromagnetic pulses are known as HPEM (High-Power ElectroMagnetics). Commonly known high-power pulse generators, such as the Marx generator or a vircator are sources of pulsed microwave radiation and are dubbed HPM (High-Power Microwaves). HPEM or HPM pulses can be used to damage critical infrastructure at state or crisis response services as part of a terrorist attack.

### Metrology of HPEM and HPM pulses

A sample HPM pulse and its spectrum are shown in Fig. 1.

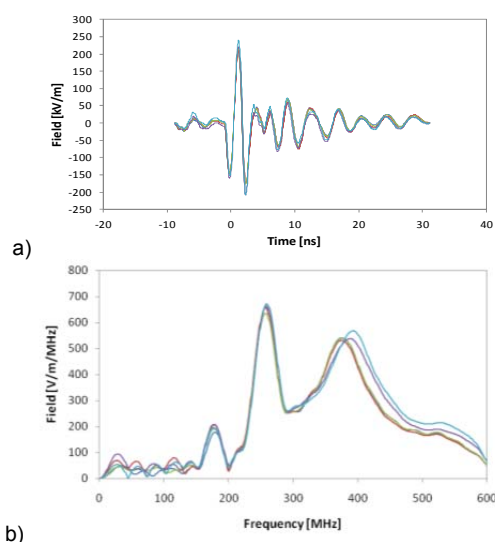

Fig. 1. HPM pulse from a Marx generator; a) electric field strength over time, b) spectrum of harmonic components as a frequency function

In the light of the potential threat from HPEM and HPM pulses, there is a need to study the outcomes of such radiation acting on the electronics of devices and communication systems, as well as to design technical

measures for protecting such equipment against the destructive power of HPEM and HPM pulses. An important element of these actions is constructing a meter intended for measuring pulsed HPEM and HPM radiation. It is impossible to use the meters currently available on the market for measuring HPEM and HPM pulses, due to the extremely short duration of the measured pulses and the fact that such devices would be immediately destroyed in such strong electromagnetic fields. Laboratory equipment is based on simple sets constructed on the basis of stationary oscilloscopes, attenuator sets and straight forward computer devices for determining the basic parameters and features of measured signals. They are located in a separate, shielded laboratory room, Fig. 2 [1].

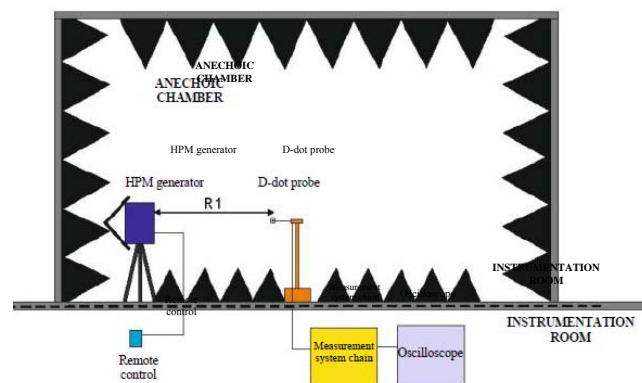

Fig. 2 Laboratory measurements of HPEM and HPM signals

There are no devices of any sort for measuring HPEM and HPM signals in environmental conditions. They should enable operation in a much harsher regime than laboratory equipment. And it is not only about temperature, also negative, and humidity, but also rain. Protecting the electronic components of the meter against being damaged in a pulsed EM field is becoming a major challenge.

### Method of HPEM and HPM signal environmental measurements

In order to rise up to such tasks, first of all, the functional blocks of the meter should be separated and connected via safe links, which enable independent, remote field operation, Fig. 3 [1]

The detection assembly primarily consists of broadband measuring probes, most frequently used in practice. Unfortunately, the selected method has numerous downsides. They result mainly from the huge difference in the level of the signal detected by a receiving antenna, and the level of the signal, which can be safely sent to electronic circuits for processing purposes. For this reason, an antenna detector comes with a series of systems (attenuators, power limiter), which are aimed at attenuating the signal and matching its value to one that can be processed by the digital systems of the meter. The last of the functional blocks of the meter is the signal processing assembly, which, owing to the high number of electronic subassemblies and devices, has to be far from the destructive action of pulsed EM fields. This safe distance is at least several dozen, preferably several hundred meters away from the source of the pulsed signal.



Fig. 3 Block diagram of a field electromagnetic signal meter

With the developed fibre optic technology, this challenge does not seem too complicated, yet it requires enhancing the *Matching assembly* with additional electronic components, such as a fibre optic signal transmitter, autonomous power supply, etc. The *Matching assembly* is located in the area of direct impact from destructive EM fields, which is why the electronic elements used therein must be protected with appropriate absorbers.

#### Field meter for HPEM and HPM signals

As part of a research project, Grant No. DOB-1-3/1/PS/2014\_PSOB/16-062/2014/WAT/P, the employees of the Department of IT and Measuring Systems of the Faculty of Electronics at the Military University of Technology (WEL WAT) developed and constructed a field meter for measuring the parameters and characteristics of high-power pulsed EM fields (PM-HPM1), Fig. 4.



Fig. 4. PM-HPM1 field meter

The PM-HPM1 is an autonomous meter intended for conducting field measurements of the intensity of very strong pulsed electromagnetic fields (HPM), Fig. 1. It is a broadband device measuring pulsed electromagnetic radiation over a frequency range of 0.01 GHz to 12 GHz. The PM-HPM1 meter is equipped with a D-dot probe, which measures the electric component (E) of the field and

enables measuring the parameters of electromagnetic field strength over up to 4 hours, with the battery fully charged. The intensity of the measured field can be expressed in units [V/m] or power density [W/m<sup>2</sup>].

It measures both the electromagnetic field strength parameters, as well as time parameters of the pulses, and also spectral parameters for signals with frequencies below 1 GHz.

The software of the meter allows to save the final results of the measurements on a computer hard drive, as well as to copy them to other media and to load them.

Basic parameters:

operating frequency range

- 10 MHz - 1 GHz,

- 1 GHz - 12 GHz,

pulse duration

- 2ns-300 μs,

continuous operation

- 4 h,

strength of measured fields

5 V/m – 500 kV/m – for a frequency range of 1-12GHz

50V/m – 500 kV/m – for a frequency range of 10 MHz-1GHz

#### Impact of temperature on the obtained results

The laboratory tests take over the researcher's distress associated with the impact of temperature on the operation of individual measuring system components, hence, on the obtained final results. Researchers subconsciously assume that they are conducted in conditions similar or very close to the conditions recommended as operating for electronic subassemblies, and at the same time to conditions, in which a measuring device is verified. The operating temperature of a measuring device in environmental conditions can slightly differ from the recommended correct operating temperature. These may include extremely high temperatures reaching 50<sup>o</sup> C or as low as - 20<sup>o</sup> C. This is the operating temperature range for a measuring device that should be ensured.

The autonomous power supply will be particularly sensitive to temperature changes. Its task is to provide electricity for all subassemblies of a meter over a specified period of time - 1, 2, .., n hours of operation. The measurement method shall assume separating the meter's functional block, so that only a part of the power supply system, the one located close to the *detection assembly*, is directly exposed to the temperature factor. The remaining, primary section of the autonomous power supply shall be protected by, e.g. placing meter components in a heated tent, car, etc., Fig. 5.

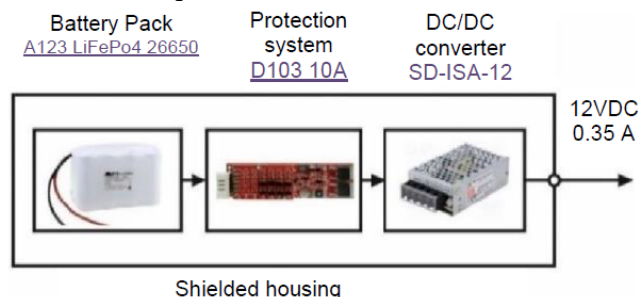

Fig. 5. Block diagram of the selected power supply solution in the shielded section of the HPM meter

Selected subassemblies were subjected to comprehensive temperature tests over a range of - 20 °C + +55 °C, which involved checking the level of voltages supplying the electronic systems located within a shielded

housing, as well as the operating time with correct power supply. The tests were conducted using a LabEvent LC/100/70/10 climatic chamber. The test results are presented in Fig. 6 and Fig. 7 [1].

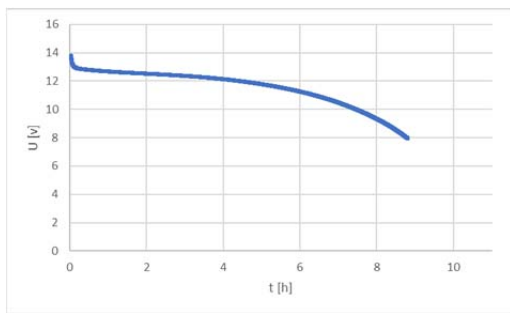

Fig. 6 Voltage change characteristics as a function of time, on the outlet from a battery pack, during discharging with a current of 0, 1C=500mA in a climatic chamber, at a temperature of  $-20^{\circ}\text{C}$

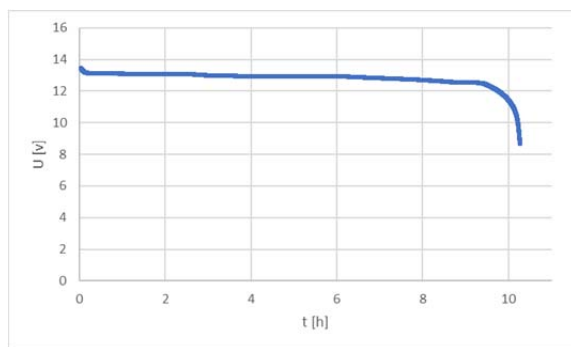

Fig. 7 Voltage change characteristics on the system outlet during a battery pack discharge with a current of 0, 1C=500mA in a climatic chamber, at a temperature of  $55^{\circ}\text{C}$

Checking a power supply system in low temperatures does not guarantee the correct operation of an HPM signal meter in environmental conditions. The execution of this task is particularly difficult. It is associated with the need to develop and construct additional testing systems, which would exhibit the properties of HPM signals (ability to control an entire measurement chain of a meter, from an antenna to an industrial computer). At the same time, they would be so weak that using them would not damage the electronic equipment within the climatic chamber area of installation.



Fig. 8. View of a generator-tested located upstream of a D-dot probe

The meter's test systems, exhibiting the aforementioned properties, were developed by the Team and used to verify the correct operation of the meter, over a wide range of temperature changes, Fig. 8 [1].

The conducted preliminary tests indicated correct operation of the generator-tester. An activated generator-tester generates a continuous electromagnetic field with a constant strength (observed over a time interval) and constant frequency, Fig. 9.

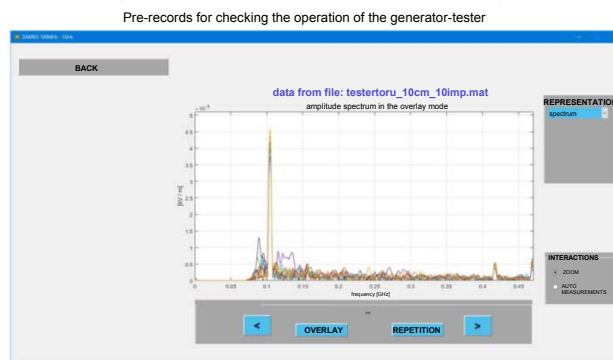
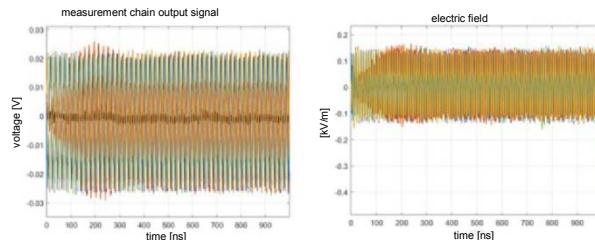

Spectrum of the recorded generator-tester signal

Fig. 9. Tests using a generator-tester

The evaluation of PM-HPM1 meter's correct operation, upon significant temperature changes, primarily focused on testing the antenna-matching assembly (ZAD assembly). Pursuant to the adopted measurement method in environmental conditions, exactly this assembly will be exposed to the action of adverse climatic conditions. The ZAD assembly was placed in a climatic chamber and subjected to temperature tests over 2 temperature ranges. The first one involved cooling the ZAD assembly down to a temperature of  $-20^{\circ}\text{C}$  and holding in this temperature for at least 4.5 hours. In the second case, the ZAD assembly, placed in a LabEvent LC/100/70/10 climatic chamber, was heated to a temperature of  $+55^{\circ}\text{C}$ , Fig. 10 [1].

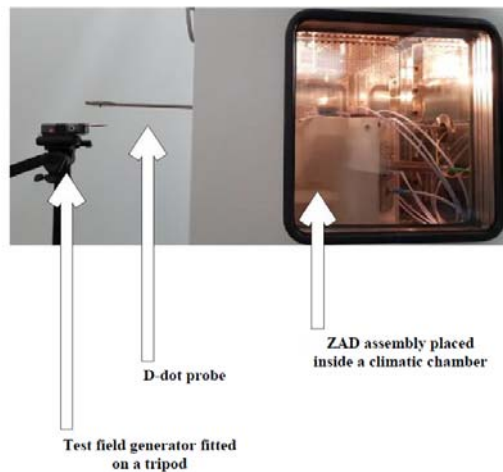
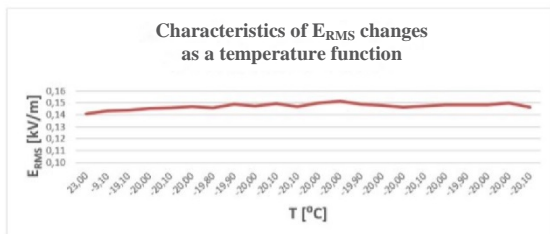
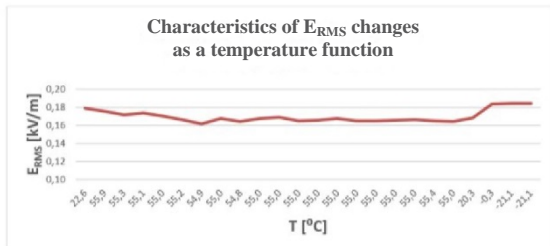

Fig. 10. ZAD assembly in the course of climatic chamber tests

The conducted tests were used as a base to determine the change characteristics regarding the effective value of the EM field generated by the test generator, as a temperature change function, Fig. 11.



Characteristics of ERMS changes as a temperature function, approaching low temperatures to - 20 °C



Characteristics of ERMS changes as a temperature function, approaching low temperatures to + 55 °C

Fig. 11 Change of the effective value of measured EM field strength as a temperature change function

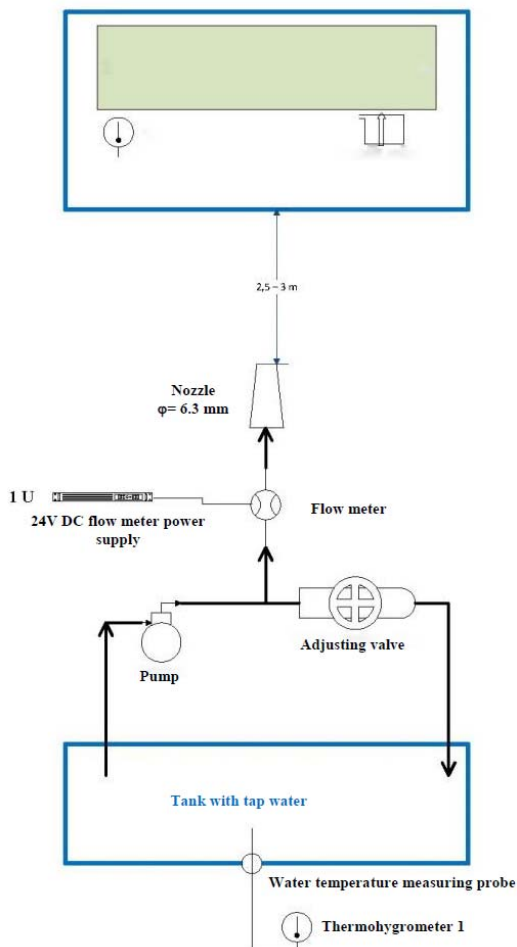

Fig. 12 Diagram of the test rig for testing the IPX5 housing degree of protection

Based on the conducted degree of protection tests it can be concluded that the ZAD assembly housings correctly protect electronic elements of the meter comprising this assembly, to a degree in conformity with the IPX5 class.

### Conclusions

Preparing measuring instruments for conducting environmental tests requires both an analysis regarding the course of the experiment, as well as performing a number of auxiliary tests to confirm a metrologically-correct operation of the measuring devices and systems.

*Task co-financed by the National Centre for Research and Development, within project No. DOB-1-3/1/PS/2014 "Methods and manners of protecting and defending against HPM pulses", and devoted to a task titled "Developing a concept of a portable high-power electromagnetic field meter".*

**Authors:** dr hab. inż. Marek Kuchta Instytut Systemów Elektronicznych, ul. Kaliskiego 2, 00-908 Warszawa, E-mail: [marek.kuchta@wat.edu.pl](mailto:marek.kuchta@wat.edu.pl);  
 dr hab. inż. Jacek Jakubowski, Wojskowa Akademia Techniczna, Wydział Elektroniki, Instytut Systemów Elektronicznych, ul. Kaliskiego 2, 00-908 Warszawa, E-mail: [jacek.jakubowski@wat.edu.pl](mailto:jacek.jakubowski@wat.edu.pl);  
 prof. dr hab. inż. Roman Kubacki, Wojskowa Akademia Techniczna, Wydział Elektroniki, Instytut Telekomunikacji, ul. Kaliskiego 2, 00-908 Warszawa, E-mail: [roman.kubacki@wat.edu.pl](mailto:roman.kubacki@wat.edu.pl);

### REFERENCES

- [1] Report covering the task PSOB/16-062/2014/WAT/P, Faculty of Elect., MUT, 2019, 2020.
- [2] Standard PN - EN 60529:2003, *Degrees of protection provided by enclosures (IP Code)*,