

doi:10.15199/48.2017.12.05

# Real-time measurement of signal to noise ratio for harmonic signals

**Abstract.** The paper presents a new real time measuring method of the ratio of sinusoidal signal power to noise power. The recursive estimation procedure was developed on the basis of maximum-likelihood (ML) method with use of the stochastic approximation technique. The performance of the algorithm was checked by means of numerical simulations, which revealed its high efficiency and low numerical load, what enables to use it in real time systems.

**Streszczenie.** W artykule zaprezentowano nową metodę wyznaczania w czasie rzeczywistym stosunku sygnału do szumu w przypadku sygnałów harmonicznym. Rekursywna procedura estymacji została opracowana przy wykorzystaniu estymatora największej wiarygodności oraz metody aproksymacji stochastycznej. Wyniki badań symulacyjnych potwierdziły wysoką efektywność algorytmu i niewielkie obciążenie obliczeniowe. **Pomiar w czasie rzeczywistym stosunku sygnału do szumu dla sygnałów harmonicznym.**

**Keywords:** signal to noise ratio, real time estimation, maximum-likelihood estimation.

**Słowa kluczowe:** stosunek sygnału do szumu, estymacja w czasie rzeczywistym, estymator największej wiarygodności.

## Introduction

Noise and disturbances which influence the transmission process in electronic and telecommunication systems may deteriorate performance of detection and decoding transmitted information [1, 2, 3]. It is especially troublesome in a case of weak signals on high level noise background and negligible for strong signals. As the relation between signal and noise levels is important to receiving process, the vast majority of detection methods explicitly or implicitly rely on information about relation of signal power to noise power called signal to noise ratio (SNR). The performance of the methods depend on the accuracy of information on SNR. Many techniques are based on a priori knowledge on SNR level. This idea is sufficient for stationary systems, where SNR assessed theoretically or measured initially is valid for all the time. However, in a case of non-stationary conditions, as for instance in case of emerge of electromagnetic disturbances [4], compatibility issues [5, 6], abrupt changes of transmission channel properties [3, 7], signal fluctuations and even intended jamming, obtaining reliable SNR information in real time may pose a challenge. Estimation of the parameter is mainly done with use of two methods: the method of moments (MM) [8, 9] or maximum likelihood (ML) [10,11]. The second approach is characterised by faster convergence time than the first one, but requires higher calculation load. However, algorithms intended for use in real time systems should have low numerical burden.

The scope of the paper is to present reliable method allowing measuring the ratio of sinusoidal signal power to noise power with low calculation load, which is dedicated to real time systems. The algorithm is based on ML technique with use of stochastic approximation. Its idea was presented by authors in [12] and is described in detail in sections II and III. In section IV results of simulation investigations are presented.

## Carrier signal with noise in narrowband systems

Electronic and telecommunication transmission systems are narrowband, so the noise on the output of the receiver is also narrowband. Two examples of harmonic signal with narrowband noise at level of  $SNR = 0 \text{ dB}$  and  $SNR = 10 \text{ dB}$  are presented in Fig. 1. The picture illustrates the problem mentioned in the introduction.

It is known [1, 13] that in a case of narrowband receivers, the envelope of received sinusoidal carrier signal corrupted by Gaussian noise can be described by the Rice

distribution. Examples of probability density functions  $w(x)$  of the envelope of sinusoidal signal with narrowband noise for different SNRs are presented in Fig. 2.

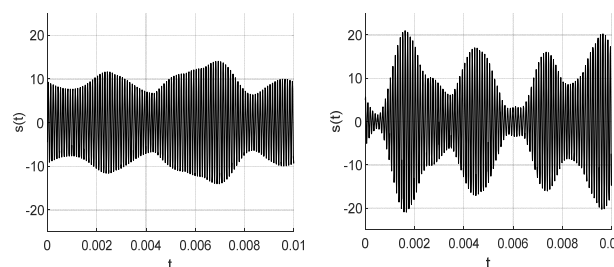

Fig.1. An example of harmonic signal with narrowband noise at  $SNR = 10 \text{ dB}$  (left),  $SNR = 0 \text{ dB}$  (right)

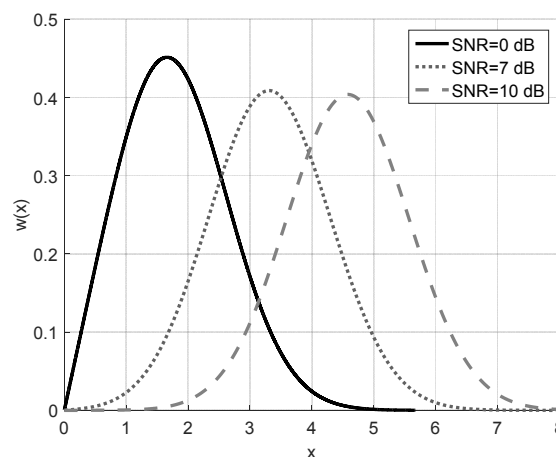

Fig.2. Probability density functions  $w(x)$  for the sinusoidal signal with narrowband noise for different SNRs

As can be seen in Fig. 2, the properties of the probability density functions depend on SNR level. This feature can constitute the basis of assessing SNR value with using ML estimation.

The probability density function (pdf) of the Rice distribution in its normalized form can be presented as (1):

$$(1) \quad w(x) = x \cdot \exp\left(-\frac{x^2 + a^2}{2}\right) \cdot I_0(ax)$$

where:  $x$  is measured signal envelope value,  $I_0(ax)$  is modified zero order Bessel function. The  $a$  parameter has a sense of signal to noise ratio:

$$(2) \quad a = \frac{U_{ms}}{\sigma}$$

where  $\sigma$  is standard deviation of the noise,  $U_{ms}$  denotes signal amplitude.

### SNR estimation algorithm

Having such mathematical model, the issue of SNR estimation can be formulated as the problem of the parameter  $a$  estimation. The ML approach can be applied.

For  $N$  independent measurements, the probability density function can be written as:

$$(3) \quad L(x, a) = \prod_{k=1}^N w(x_k, a)$$

where  $N$  is a number of measurements,  $x_k$  is  $k$ -th measured sample.

The ML estimate is the solution [14] of the following log likelihood equation:

$$(4) \quad \frac{\partial}{\partial a} \ln L(x, a) = 0$$

which leads to the following result:

$$(5) \quad \frac{1}{N} \sum_{k=1}^N \frac{\partial}{\partial a} \ln w(x_k, a) \cong E \left[ \frac{\partial}{\partial a} \ln w(x_k, a) \right] = 0$$

where  $E[*]$  is expected value due to  $x_k$  and:

$$(6) \quad \frac{\partial}{\partial a} \ln w(x_k, a) = \frac{x_k}{a} \frac{I_1(a \cdot x_k)}{I_0(a \cdot x_k)} - 1$$

where  $I_0(*)$ ,  $I_1(*)$  are the modified Bessel type  $I$  functions of 0 and 1 order.

Direct use of the ML method may not be possible because in this case the ML equation has no analytical solution. However, it is possible to use the idea of stochastic approximation [15] and to perform the recursive estimation procedure. Thus, to solve (5), the stochastic approximation algorithm can be applied as follows:

$$(7) \quad a_k = a_{k-1} - \gamma_k D(x_k, a_{k-1})$$

where:

$$(8) \quad D(x_k, a_{k-1}) = \frac{\partial}{\partial a} \ln w(x_k, a_{k-1})$$

The recursive solution is the following:

$$(9) \quad a_k = a_{k-1} - \gamma_k \left[ x_k \frac{I_1(a_{k-1} x_k)}{I_0(a_{k-1} x_k)} - a_{k-1} \right]$$

The block diagram of the implementation of the algorithm (9) is shown in Fig. 3.

Finally, the estimated SNR value at time step  $k$  is calculated as:

$$(10) \quad SNR_k = \frac{(a_k)^2}{2}$$

Accuracy of parameter  $a_k$  estimate and estimation process convergence rate depend on the parameter  $\gamma_k$ .

The optimal value  $\gamma_{kopt}$  can be found by taking the criterion of the minimum estimation error at every measurement step.

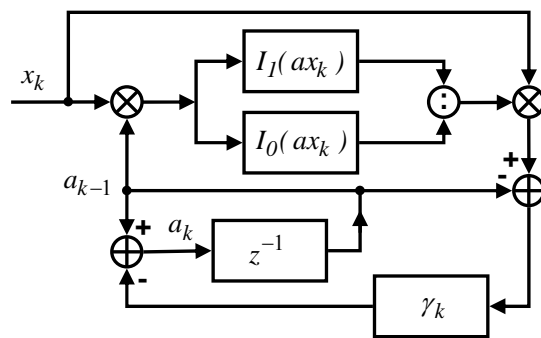

Fig.3. Block diagram of the proposed algorithm implementation

If we look for solution in a form of linear estimator, then the equation (8) becomes:

$$(11) \quad D(x_k, a_{k-1}) \cong K(a_{k-1} - a_0) + \varepsilon_{k-1} \sigma_\varepsilon$$

where  $\varepsilon_k$  is discrete stochastic process with parameters:  $E[\varepsilon_k] = 0$ ,  $var[\varepsilon_k] = 1$ , while:

$$(12) \quad K = E \left[ \frac{\partial}{\partial a} D(x_k, a_{k-1}) \right]_{a=a_0}$$

$$\sigma_\varepsilon^2 = var[D(x_k, a_{k-1})]$$

where  $K$  and  $\sigma_\varepsilon^2$  can be found on the basis of (1).

Let's consider two cases: big and small value of  $a$  (high and low level of SNR).

Assuming  $a \gg 1$  and using the Bessel approximation for big value arguments, we obtain:

$$K = -1, \quad \sigma_\varepsilon^2 = 1$$

$$(13) \quad \frac{\partial}{\partial \gamma} E[(a_k - a_0)^2] = 0$$

and finally:

$$(14) \quad \gamma_{kopt} = - \left( k + \frac{1}{\sigma_0^2} \right)^{-1}$$

where  $\sigma_0^2$  is the a priori value of variance of the measured parameter.

In case of  $a < 1$  the optimal value  $\gamma_{kopt}$  cannot be directly found, since the values of  $K$  and  $\sigma_\varepsilon$  from (11) are functions of the unknown measured parameter:

$$(15) \quad K \approx -1 + \exp\left(-\frac{a_0^2}{2}\right) \left(1 + 1,5a_0^2\right)$$

$$(16) \quad \sigma_\varepsilon^2 \approx a_i^2 \exp\left(-\frac{a_0^2}{2}\right) \left(2 - \exp\left(-\frac{a_0^2}{2}\right)\right)$$

Therefore for small  $a < 1$  the parameter  $\gamma_{kopt}$  can be obtained using (12). As a result, estimates in this case do not have asymptotic efficiency (they are not optimal), but for  $a \approx 1$  (which is the case for most measurements) the  $\gamma_k$  in form of (12) has asymptotic efficiency, whereas:

$$(17) \quad E[a_k - a_0]_{k \rightarrow \infty} \approx \frac{I}{kI}$$

where:  $I$  denotes the following information on probability density function:

$$(18) \quad I = \int_{\Omega} \frac{|w'(x)|^2}{w(x)} dx$$

### Improvements of numerical efficiency

Block diagram of the proposed algorithm implementation, which is presented in Fig. 3, shows that the estimator has simple and easy to implement structure. It requires few numerical calculations except realisation of  $I_1(a \cdot x_k) / I_0(a \cdot x_k)$  blocks, where value of two Bessel functions should be calculated every time step  $k$ . However, this part of the system is actually a nonlinear block whose characteristics is shown in Fig. 4. Its value can be precalculated and placed in look-up table. For short tables, linear interpolation should be used. Our simulation studies have shown that this approach does not show noticeable differences with respect to analytical calculations.

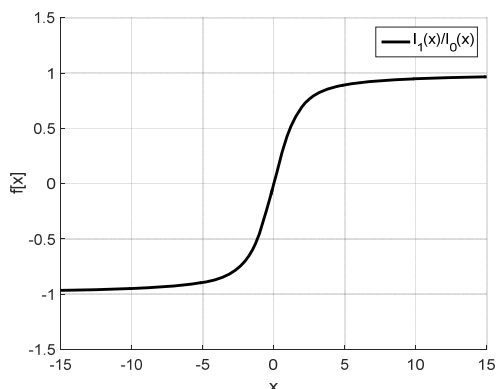

Fig.4. Nonlinear block  $I_1(x)/I_0(x)$

The final the structure of the proposed estimator is presented in Fig. 5.

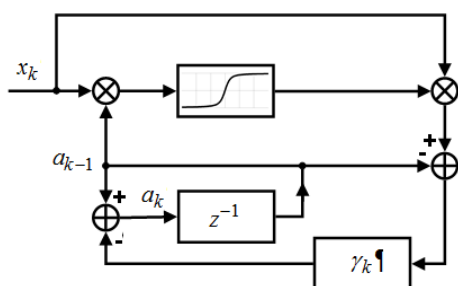

Fig.5. Block diagram of the algorithm implementation with use of nonlinear block

### Simulation results

The performance of the proposed method was investigated in simulations with use of Monte Carlo approach with  $N=100$  runs performed in Matlab environment. The results presented below were carried out for bandpass system with central frequency  $f_c=10kHz$  and bandwidth  $B=1kHz$ . The signal under the test was comprised of sinusoidal signal with additive Gaussian noise. The frequency of the signal was  $f_o=10kHz$  and phase was randomly drawn from range  $\varphi \in (0, 2\pi)$  rad for each simulation run. The noise was simulated as zero mean Gaussian process with variance adequate to assumed SNR. Frequency of sampling was set as  $f_s=100kHz$ .

In Fig. 6 and Fig. 8 examples of SNR estimation process with use of proposed method is shown. Figures present results for two cases:  $SNR=10$  dB and  $SNR=0$  dB.

Fig. 7 and Fig. 9 present root mean square error (RMSE) of SNR estimation. In the pictures the performance of the proposed algorithm is compared to RMSE of the MM. The realisation of the moment fit is based on determination of Rice distribution parameters by adjusting two moments (mean, variance) with use of Nelder-Mead simplex optimization technique. The moment fit estimation is started after completing  $N=10$  samples and is regularly redone after acquisition of each new signal measurement. In Fig. 7 and Fig. 9 results for two SNR levels are shown:  $SNR=10$  dB and  $SNR=0$  dB

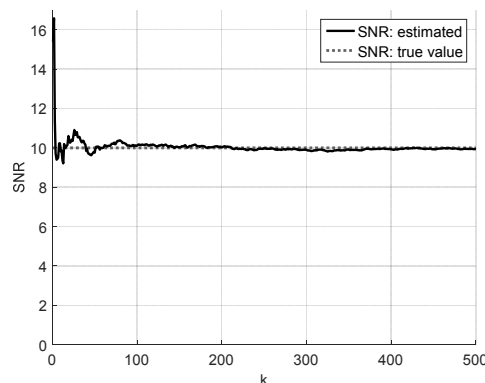

Fig.6. An example of SNR estimation process with use of the proposed method ( $SNR=10$  dB)

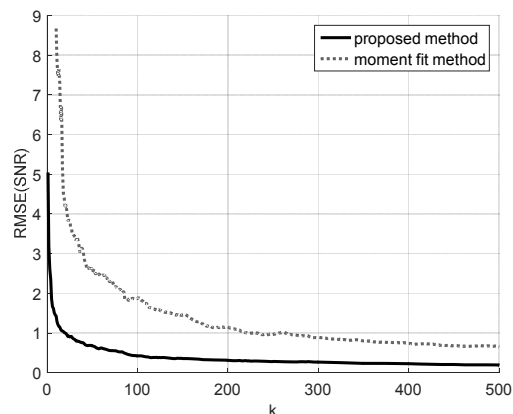

Fig.7. Comparison of the RMSE of SNR estimation with use of proposed method and MM fit ( $SNR=10$  dB)

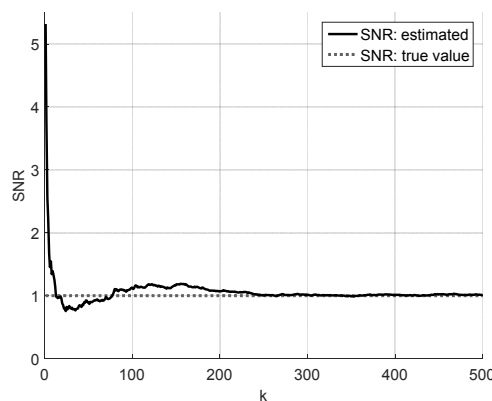

Fig.8. An example of SNR estimation process with use of the proposed method ( $SNR=0$  dB)

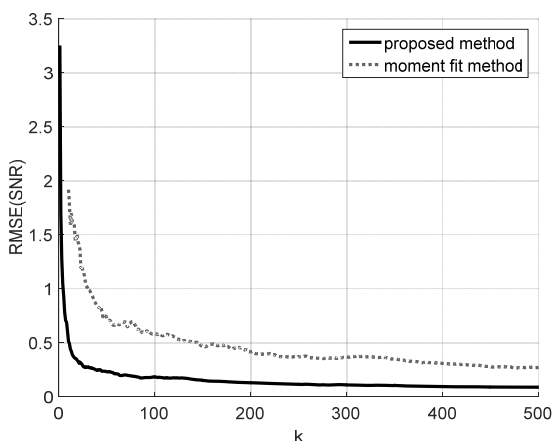

Fig.9. Comparison of the RMSE of SNR estimation with use of proposed method and MM fit ( $SNR=0$  dB)

Fig. 10 presents relative RMS error in steady state conditions ( $k>500$ ) as a function of the SNR level.

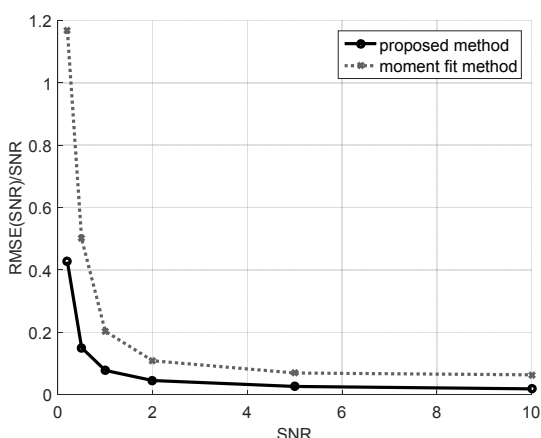

Fig.10. RMSE related to SNR value for various SNR levels

As can be seen from Fig. 6 - Fig. 10, the proposed algorithm reveals good performance. The estimated value reaches true value of SNR in quite short time and has small RMS error. The proposed method reveals better performance than widely used MM both in RMS error and much lower calculation burden.

## Conclusions

The paper presents a new suboptimal estimation method allowing measuring the ratio of sinusoidal signal power to noise power. The proposed algorithm is derived on the basis of maximum likelihood technique with use of stochastic approximation to obtain solution. The outgoing result has a form of recursive estimation procedure. The simulation results have revealed a high efficiency of the proposed algorithm and low numerical burden, which designates the method to real time systems.

The research was conducted within the project S/WE/1/2015, financially supported by Polish Ministry of Science and Higher Education.

**Authors:** prof. dr hab. inż. Jurij Griszin, Politechnika Białostocka, Wydział Elektryczny, ul. Wiejska 45 D, 15-351 Białystok, E-mail: [j.griszin@pb.edu.pl](mailto:j.griszin@pb.edu.pl); dr inż. Dariusz Jańczak, Politechnika Białostocka, Wydział Elektryczny, ul. Wiejska 45 D, 15-351 Białystok, E-mail: [d.janczak@pb.edu.pl](mailto:d.janczak@pb.edu.pl).

## REFERENCES

- [1] Haykin S., Moher M., An Introduction to Analog and Digital Communications, Wiley, 2007
- [2] Konopko K., The comparison of probability density function estimation for signal detection in impulse noise, *Przegląd Elektrotechniczny*, 86 (2010), No. 3, 36-37
- [3] Penttinen J. T. (ed.), The Telecommunications Handbook: Engineering Guidelines for Fixed, Mobile and Satellite Systems. John Wiley & Sons, 2015
- [4] Janczak D., An adaptive algorithm of state estimation in the presence of multiplicative interference, *Przegląd Elektrotechniczny*, 86 (2010), No. 3, 30-31
- [5] Zankiewicz A., Susceptibility of IEEE 802.11n networks to adjacent-channel interference in the 2.4GHz ISM band, *Przegląd Elektrotechniczny*, 88 (2012), No. 9b, 287-288
- [6] Sadowski M., Litwinczuk N., Simulation and experimental researches of the linear broadband antenna array, XVIII International Conference: Electromagnetic disturbances, EMD'2008, Vilnius, September 25-26, 2008, 103-106
- [7] Janczak D., Griszin J., Data processing algorithm for the Rayleigh fading channels, *Przegląd Elektrotechniczny*, 88 (2012), No. 8, 68-71
- [8] Stephenne A., Bellili F., Affes S., Moment-based SNR estimation over linearly-modulated wireless SIMO channels, *IEEE Transactions on Wireless Communications*, 9 (2010), No. 2, 714-722
- [9] Erdogmus D., Larsson E. G., Yan R., Principe J. C., Fitzsimmons J. R., Measuring the signal-to-noise ratio in magnetic resonance imaging: a caveat, *Signal Processing*, 84 (2004), Issue 6, 1035-1040
- [10] Sijbers J., den Dekker A. J., Scheunders P., Van Dyck D., Maximum-likelihood estimation of Rician distribution parameters, *IEEE Transactions on Medical Imaging*, 17 (1998), No. 3, 357-361
- [11] Yakovleva T. V., Kulberg N. S., Noise and Signal Estimation in MRI: Two-Parametric Analysis of Rice-Distributed Data by Means of the Maximum Likelihood Approach, *American Journal of Theoretical and Applied Statistics*, 2 (2013), Issue 3, 67-80
- [12] Griszin J., Janczak D., Real time estimation of signal to noise ratio, XXIV International Conference: Electromagnetic disturbances, EMD'2017, Białystok, September 20-22, 2017, 31-33
- [13] Durgin G. D., Rappaport T. S., de Wolf D. A., New analytical models and probability density functions for fading in wireless communications, *IEEE Transactions on Communications*, vol. 50 (2002), No. 6, 1005-1015
- [14] Kay S., Fundamentals of statistical signal processing: Estimation theory. Prentice-Hall, 1993
- [15] Benveniste A., Metivier M., Priouret P., Adaptive algorithms and stochastic approximations. Berlin, Springer-Verlag, 1990